

**TYPES SN54107, SN54LS107A,
SN74107, SN74LS107A**
DUAL J-K FLIP-FLOPS WITH CLEAR
REVISED DECEMBER 1983

- Package Options Include Both Plastic and Ceramic Chip Carriers in Addition to Plastic and Ceramic DIPs
- Dependable Texas Instruments Quality and Reliability

description

The '107 contain two independent J-K flip-flops with individual J-K, clock, and direct clear inputs. The '107 is a positive pulse-triggered flip-flop. The J-K input is loaded into the master while the clock is high and transferred to the slave on the high-to-low clock transition. For these devices the J and K inputs must be stable while the clock is high.

The 'LS107A contain two independent negative-edge-triggered flip-flops. The J and K inputs must be stable one setup time prior to the high-to-low clock transition for predictable operation. When the clear is low, it overrides the clock and data inputs forcing the Q output low and the \bar{Q} output high.

The SN54107 and the SN54LS107A are characterized for operation over the full military temperature range of -55°C to 125°C. The SN74107 and the SN74LS107A are characterized for operation from 0°C to 70°C.

SN54107, SN54LS107A ... J PACKAGE
SN74107 ... J OR N PACKAGE
SN74LS107A ... D, J OR N PACKAGE

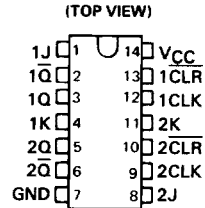

SN54LS107A ... FK PACKAGE
SN74LS107A ... FN PACKAGE

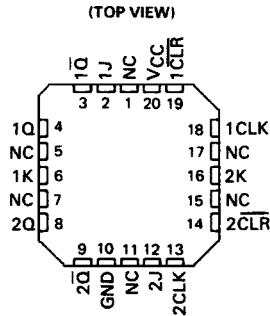

NC - No internal connection

'107
FUNCTION TABLE

INPUTS				OUTPUTS	
CLR	CLK	J	K	Q	\bar{Q}
L	X	X	X	L	H
H	\downarrow	L	L	Q_0	\bar{Q}_0
H	\downarrow	H	L	H	L
H	\downarrow	L	H	L	H
H	\downarrow	H	H	TOGGLE	

'LS107A
FUNCTION TABLE

INPUTS				OUTPUTS	
CLR	CLK	J	K	Q	\bar{Q}
L	X	X	X	L	H
H	\downarrow	L	L	Q_0	\bar{Q}_0
H	\downarrow	H	L	H	L
H	\downarrow	L	H	L	H
H	\downarrow	H	H	TOGGLE	
H	H	X	X	Q_0	\bar{Q}_0

PRODUCTION DATA

This document contains information current as of publication date. Products conform to specifications per the terms of Texas Instruments standard warranty. Production processing does not necessarily include testing of all parameters.



TYPES SN54107, SN54LS107A,
 SN74107, SN74LS107A
 DUAL J-K FLIP-FLOPS WITH CLEAR

logic diagrams

'107

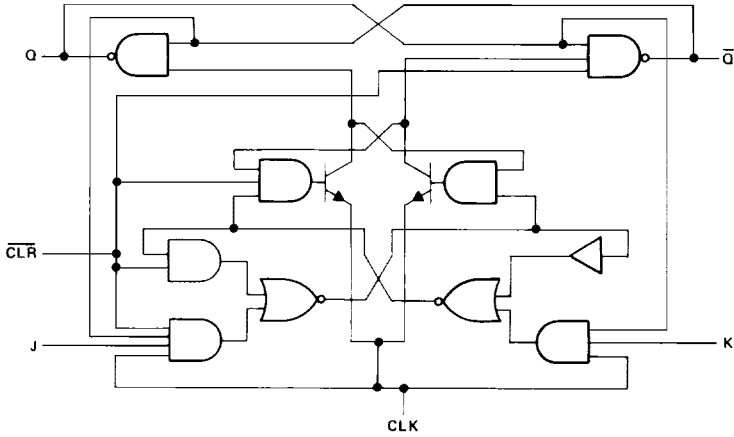

'LS107A

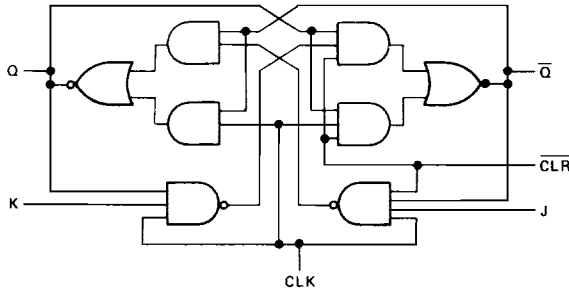

3

TTL DEVICES

**TYPES SN54107, SN54LS107A,
SN74107, SN74LS107A
DUAL J-K FLIP-FLOPS WITH CLEAR**

logic symbols

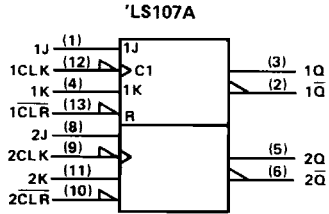
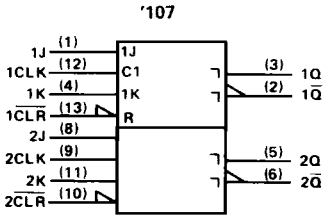

Pin numbers shown on logic notation are for D, J or N packages.

schematic of inputs and outputs

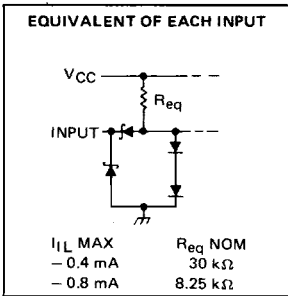
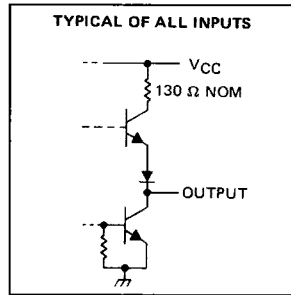
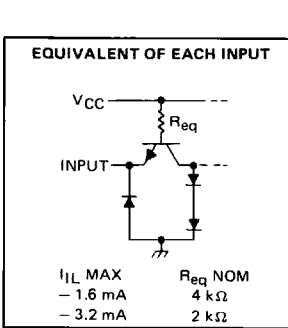

'LS107A

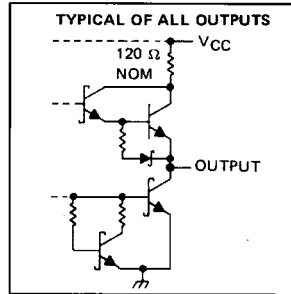

absolute maximum ratings over operating free-air temperature range (unless otherwise noted)

Supply voltage, V_{CC} (see Note 1)	7 V
Input voltage: '107	5.5 V
'LS107A	7 V
Operating free-air temperature range: SN54'	-55°C to 125°C
SN74'	0°C to 70°C
Storage temperature range	-65°C to 150°C

NOTE 1: Voltage values are with respect to network ground terminal.

3

TTL DEVICES

TYPES SN54107, SN74107

DUAL J-K FLIP-FLOPS WITH CLEAR

recommended operating conditions

		SN54107			SN74107			UNIT
		MIN	NOM	MAX	MIN	NOM	MAX	
V_{CC}	Supply voltage	4.5	5	5.5	4.75	5	5.25	V
V_{IH}	High-level input voltage	2			2			V
V_{IL}	Low-level input voltage	0.8			0.8			V
I_{OH}	High-level output current	-0.4			-0.4			mA
I_{OL}	Low-level output current	16			16			mA
t_w	Pulse duration	CLK high		20	20		ns	
		CLK low		47	47			
		CLR low		25	25			
t_{su}	Input setup time before CLK†	0			0			ns
t_h	Input hold time-data after CLK†	0			0			ns
T_A	Operating free-air temperature	-55		125	0		70	°C

electrical characteristics over recommended operating free-air temperature range (unless otherwise noted)

PARAMETER	TEST CONDITIONS†		SN54107			SN74107			UNIT
			MIN	TYP‡	MAX	MIN	TYP‡	MAX	
V_{IK}	$V_{CC} = \text{MIN}, I_I = -12 \text{ mA}$		-1.5			-1.5			V
V_{OH}	$V_{CC} = \text{MIN}, I_{OH} = -0.4 \text{ mA}$		2.4	3.4		2.4	3.4		V
V_{OL}	$V_{CC} = \text{MIN}, I_{OL} = 16 \text{ mA}$		0.2	0.4		0.2	0.4		V
I_I	$V_{CC} = \text{MAX}, V_I = 5.5 \text{ V}$		1			1			mA
I_{IH}	J or K	$V_{CC} = \text{MAX}, V_I = 2.4 \text{ V}$	40			40			μA
	All other		80			80			
I_{IL}	J or K	$V_{CC} = \text{MAX}, V_I = 0.4 \text{ V}$	-1.6			-1.6			mA
	All other		-3.2			-3.2			
$I_{OS}§$	$V_{CC} = \text{MAX}$		-20	-57		-18	-57		mA
I_{CC}	$V_{CC} = \text{MAX},$ See Note 2		10	20		10	20		mA

† For conditions shown as MIN or MAX, use the appropriate value specified under recommended operating conditions.

‡ All typical values are at $V_{CC} = 5 \text{ V}, T_A = 25^\circ\text{C}$.

§ Not more than one output should be shorted at a time.

NOTE 2: With all outputs open, I_{CC} is measured with the Q and \bar{Q} outputs high in turn. At the time of measurement, the clock input is grounded.

switching characteristics, $V_{CC} = 5 \text{ V}, T_A = 25^\circ\text{C}$ (see note 3)

PARAMETER	FROM (INPUT)	TO (OUTPUT)	TEST CONDITIONS		MIN	TYP	MAX	UNIT
f_{max}			$R_L = 400 \Omega,$	$C_L = 15 \text{ pF}$	15	20		MHz
t_{PLH}	CLR	\bar{Q}			16	25		ns
t_{PHL}		Q			25	40		ns
t_{PLH}	CLK	Q or \bar{Q}			16	25		ns
t_{PHL}					25	40		ns

NOTE 3: See General Information Section for load circuits and voltage waveforms.

TYPES SN54LS107A, SN74LS107A DUAL J-K FLIP-FLOPS WITH CLEAR

recommended operating conditions

		SN54LS107A			SN74LS107A			UNIT
		MIN	NOM	MAX	MIN	NOM	MAX	
V _{CC}	Supply voltage	4.5	5	5.5	4.75	5	5.25	V
V _{IH}	High-level input voltage	2			2			V
V _{IL}	Low-level input voltage				0.8			V
I _{OH}	High-level output current	-0.4			-0.4			mA
I _{OL}	Low-level output current	4			8			mA
f _{clock}	Clock frequency	0		30	0		30	MHz
t _w	Pulse duration	CLK high		20	20		ns	
		CLR low		25	25			
t _{su}	Setup time before CLK ↓	data high or low		20	20		ns	
		CLR inactive		25	25			
t _h	Hold time-data after CLK ↓	0			20			ns
T _A	Operating free-air temperature	-55		125	0		70	°C

electrical characteristics over recommended operating free-air temperature range (unless otherwise noted)

PARAMETER	TEST CONDITIONS†		SN54LS107A			SN74LS107A			UNIT
			MIN	TYP ‡	MAX	MIN	TYP ‡	MAX	
V _{IK}	V _{CC} = MIN, I _I = -18 mA		-1.5			-1.5			V
V _{OH}	V _{CC} = MIN, V _{IH} = 2 V, V _{IL} = MAX, I _{OH} = -0.4 mA		2.5	3.4		2.7	3.4		V
V _{OL}	V _{CC} = MIN, V _{IL} = MAX, V _{IH} = 2 V, I _{OL} = 4 mA		0.25			0.4	0.25	0.4	V
	V _{CC} = MIN, V _{IL} = MAX, V _{IH} = 2 V, I _{OL} = 8 mA					0.35	0.5		
I _I	J or K	V _{CC} = MAX, V _I = 7 V	0.1			0.1			mA
	CLR		0.3			0.3			
	CLK		0.4			0.4			
I _{IH}	J or K	V _{CC} = MAX, V _I = 2.7 V	20			20			μA
	CLR		60			60			
	CLK		80			80			
I _{IL}	J or K	V _{CC} = MAX, V _I = 0.4 V	-0.4			-0.4			mA
	CLR or CLK		-0.8			-0.8			
I _{OS} §	V _{CC} = MAX, See Note 4		-20	-100		-20	-100		mA
I _{CC}	V _{CC} = MAX, See Note 2		4			6			mA

† For conditions shown as MIN or MAX, use the appropriate value specified under recommended operating conditions.

‡ All typical values are at V_{CC} = 5 V, T_A = 25°C.

§ Not more than one output should be shorted at a time, and the duration of the short circuit should not exceed one second.

NOTE 2: With all outputs open, I_{CC} is measured with the Q and \bar{Q} , outputs high in turn. At the time of measurement, the clock input is grounded.

NOTE 4: For certain devices where state commutation can be caused by shorting an output to ground, an equivalent test may be performed with V_O = 2.25 V and 2.125 V for the 54 family and the 74 family, respectively, with the minimum and maximum limits reduced to one half of their stated values.

switching characteristics, V_{CC} = 5 V, T_A = 25°C (see note 3)

PARAMETER	FROM (INPUT)	TO (OUTPUT)	TEST CONDITIONS		MIN	TYP	MAX	UNIT
f _{max}			R _L = 2 kΩ, C _L = 15 pF		30	45		MHz
t _{PLH}	CLR or CLK	Q or \bar{Q}			15	20		ns
t _{PHL}					15	20		ns

NOTE 3: See General Information Section for load circuits and voltage waveforms.

