

## 74F14 Hex Inverter Schmitt Trigger

### General Description

The 74F14 contains six logic inverters which accept standard TTL input signals and provide standard TTL output levels. They are capable of transforming slowly changing input signals into sharply defined, jitter-free output signals. In addition, they have a greater noise margin than conventional inverters.

Each circuit contains a Schmitt trigger followed by a Darlington level shifter and a phase splitter driving a TTL

totem-pole output. The Schmitt trigger uses positive feedback to effectively speed-up slow input transition, and provide different input threshold voltages for positive and negative-going transitions. This hysteresis between the positive-going and negative-going input thresholds (typically 800 mV) is determined internally by resistor ratios and is essentially insensitive to temperature and supply voltage variations.

### Ordering Code:

Order Number	Package Number	Package Description
74F14SC	M14A	14-Lead Small Outline Integrated Circuit (SOIC), JEDEC MS-120, 0.150 Narrow
74F14SJ	M14D	14-Lead Small Outline Package (SOP), EIAJ TYPE II, 5.3mm Wide
74F14PC	N14A	14-Lead Plastic Dual-In-Line Package (PDIP), JEDEC MS-001, 0.300 Wide

Devices also available in Tape and Reel. Specify by appending the suffix letter "X" to the ordering code.

### Logic Symbol

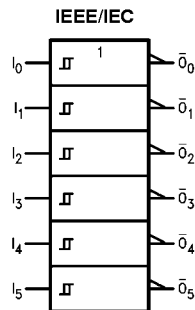

### Connection Diagram

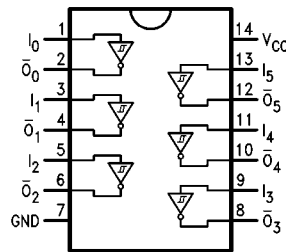

### Unit Loading/Fan Out

Pin Names	Description	U.L.	Input $I_{IH}/I_{IL}$
		HIGH/LOW	Output $I_{OH}/I_{OL}$
$I_n$	Input	1.0/1.0	20 $\mu$ A/-0.6 mA
$\bar{O}_n$	Output	50/33.3	-1 mA/20 mA

### Function Table

Input	Output
A	$\bar{O}$
L	H
H	L

H = HIGH Voltage Level  
L = LOW Voltage Level

**Absolute Maximum Ratings**(Note 1)

Storage Temperature	-65°C to +150°C
Ambient Temperature under Bias	-55°C to +125°C
Junction Temperature under Bias	-55°C to +175°C
V <sub>CC</sub> Pin Potential to Ground Pin	-0.5V to +7.0V
Input Voltage (Note 2)	-0.5V to +7.0V
Input Current (Note 2)	-30 mA to +5.0 mA
Voltage Applied to Output in HIGH State (with V <sub>CC</sub> = 0V)	
Standard Output	-0.5V to V <sub>CC</sub>
3-STATE Output	-0.5V to +5.5V
Current Applied to Output in LOW State (Max)	twice the rated I <sub>OL</sub> (mA)
ESD Last Passing Voltage (Min)	4000V

**Recommended Operating Conditions**

Free Air Ambient Temperature	0°C to +70°C
Supply Voltage	+4.5V to +5.5V

**Note 1:** Absolute maximum ratings are values beyond which the device may be damaged or have its useful life impaired. Functional operation under these conditions is not implied.

**Note 2:** Either voltage limit or current limit is sufficient to protect inputs.

**DC Electrical Characteristics**

Symbol	Parameter	Min	Typ	Max	Units	V <sub>CC</sub>	Conditions
V <sub>T+</sub>	Positive-Going Threshold	1.5	1.7	2.0	V	5.0V	
V <sub>T-</sub>	Negative-Going Threshold	0.7	0.9	1.1	V	5.0V	
ΔV <sub>T</sub>	Hysteresis (V <sub>T+</sub> -V <sub>T-</sub> )	0.4	0.8		V	5.0V	
V <sub>CD</sub>	Input Clamp Diode Voltage			-1.2	V	Min	I <sub>IN</sub> = -18 mA
V <sub>OH</sub>	Output HIGH Voltage	10% V <sub>CC</sub> 5% V <sub>CC</sub>	2.5 2.7		V	Min	I <sub>OH</sub> = -1 mA I <sub>OH</sub> = -1 mA
V <sub>OL</sub>	Output LOW Voltage	10% V <sub>CC</sub>		0.5	V	Min	I <sub>OL</sub> = 20 mA
I <sub>IH</sub>	Input HIGH Current			5.0	μA	Max	V <sub>IN</sub> = 2.7V
I <sub>BVI</sub>	Input HIGH Current Breakdown Test			7.0	μA	Max	V <sub>IN</sub> = 7.0V
I <sub>CEX</sub>	Output HIGH Leakage Current			50	μA	Max	V <sub>OUT</sub> = V <sub>CC</sub>
V <sub>ID</sub>	Input Leakage Test	4.75			V	Max	I <sub>ID</sub> = 1.9 μA All Other Pins Grounded
I <sub>OD</sub>	Output Leakage Circuit Current			3.75	μA	0.0	V <sub>IDP</sub> = 150 mV All Other Pins Grounded
I <sub>IL</sub>	Input LOW Current			-0.6	mA	Max	V <sub>IN</sub> = 0.5V
I <sub>OS</sub>	Output Short-Circuit Current	-60		-150	mA	Max	V <sub>OUT</sub> = 0V
I <sub>CCH</sub>	Power Supply Current			25	mA	Max	V <sub>O</sub> = HIGH
I <sub>CCL</sub>	Power Supply Current			25	mA	Max	V <sub>O</sub> = LOW

**AC Electrical Characteristics**

Symbol	Parameter	T <sub>A</sub> = +25°C V <sub>CC</sub> = +5.0V C <sub>L</sub> = 50 pF		T <sub>A</sub> = -55°C to +125°C V <sub>CC</sub> = +5.0V C <sub>L</sub> = 50 pF		T <sub>A</sub> = 0°C to +70°C V <sub>CC</sub> = +5.0V C <sub>L</sub> = 50 pF		Units
		Min	Max	Min	Max	Min	Max	
t <sub>PLH</sub>	Propagation Delay	4.0	10.5	4.0	13.0	4.0	11.5	ns
t <sub>PHL</sub>	I <sub>n</sub> → 0 <sub>n</sub>	3.5	8.5	3.5	10.0	3.5	9.0	

**Physical Dimensions** inches (millimeters) unless otherwise noted

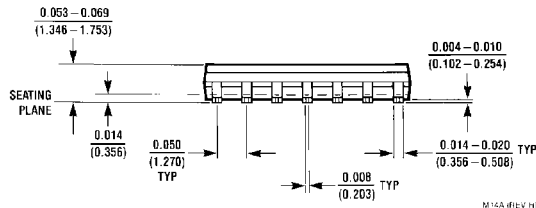
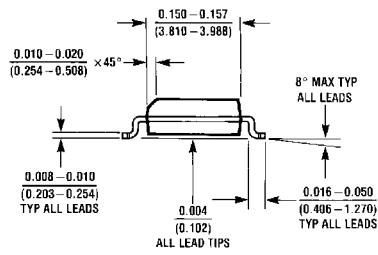
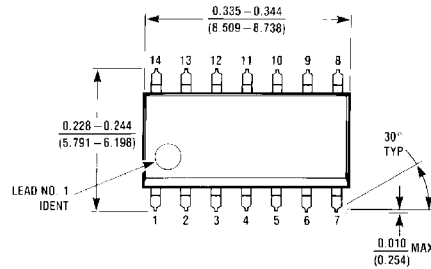

**14-Lead Small Outline Integrated Circuit (SOIC), JEDEC MS-120, 0.150 Narrow Package Number M14A**

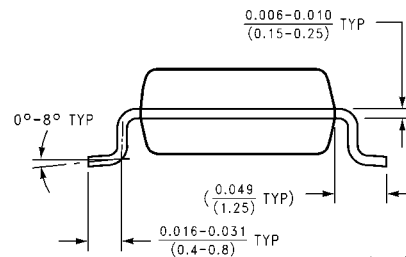
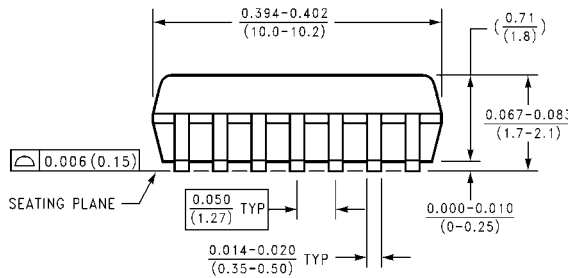
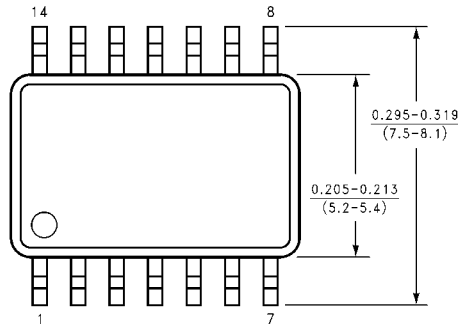

**14-Lead Small Outline Package (SOP), EIAJ TYPE II, 5.3mm Wide Package Number M14D**

**Physical Dimensions** inches (millimeters) unless otherwise noted (Continued)

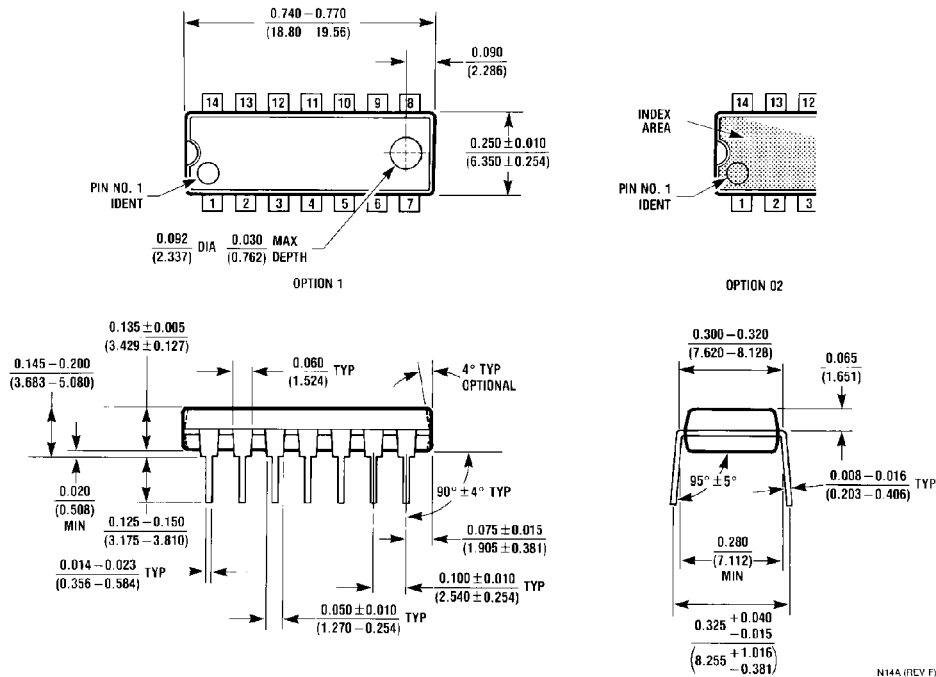

**14-Lead Plastic Dual-In-Line Package (PDIP), JEDEC MS-001, 0.300 Wide Package Number N14A**

N14A (REV F)

Fairchild does not assume any responsibility for use of any circuitry described, no circuit patent licenses are implied and Fairchild reserves the right at any time without notice to change said circuitry and specifications.

**LIFE SUPPORT POLICY**

FAIRCHILD'S PRODUCTS ARE NOT AUTHORIZED FOR USE AS CRITICAL COMPONENTS IN LIFE SUPPORT DEVICES OR SYSTEMS WITHOUT THE EXPRESS WRITTEN APPROVAL OF THE PRESIDENT OF FAIRCHILD SEMICONDUCTOR CORPORATION. As used herein:

1. Life support devices or systems are devices or systems which, (a) are intended for surgical implant into the body, or (b) support or sustain life, and (c) whose failure to perform when properly used in accordance with instructions for use provided in the labeling, can be reasonably expected to result in a significant injury to the user.
2. A critical component in any component of a life support device or system whose failure to perform can be reasonably expected to cause the failure of the life support device or system, or to affect its safety or effectiveness.

[www.fairchildsemi.com](http://www.fairchildsemi.com)