

P54/74FCT646T/AT/CT — P54/74FCT648T/AT/CT OCTAL TRANSCEIVER/REGISTER



FEATURES

- Function, Pinout and Drive Compatible with the FCT and F Logic
- FCT-C speed at 5.4ns max. (Com'I)
FCT-A speed at 6.3ns max. (Com'I)
- Reduced V_{OH} (typically = 3.3V) versions of Equivalent FCT functions
- Edge-rate Control Circuitry for Significantly Improved Noise Characteristics
- ESD protection exceeds 2000V
- Power-off disable feature
- Matched Rise and Fall times
- Fully Compatible with TTL Input and Output Logic Levels
- 64 mA Sink Current (Com'I), 48 mA (Mil)
15 mA Source Current (Com'I), 12 mA (Mil)
- Independent Register for A and B Buses
- 3-State Output
- Manufactured in 0.7 micron PACE Technology™



DESCRIPTION

The 'FCT646T' and 'FCT648T' consist of a bus transceiver circuit with 3-state, D-type flip-flops, and control circuitry arranged for multiplexed transmission of data directly from the input bus or from the internal registers. Data on the A or B bus will be clocked into the registers as the appropriate clock pin goes to a high logic level. Enable Control \bar{G} and direction pins are provided to control the transceiver function.

In the transceiver mode, data present at the high impedance port may be stored in either the A or B register, or in both. The select controls can multiplex stored and real-time (transparent mode) data. The direction control determines which bus will receive data when the enable control \bar{G} is Active LOW. In the isolation mode (enable Control \bar{G} HIGH), A data may be stored in the B register and/or B data may be stored in the A register.

7



LOGIC SYMBOL

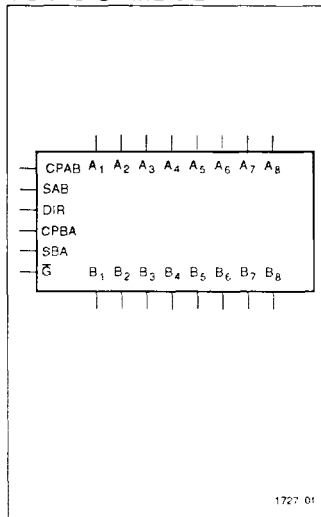

PIN CONFIGURATIONS

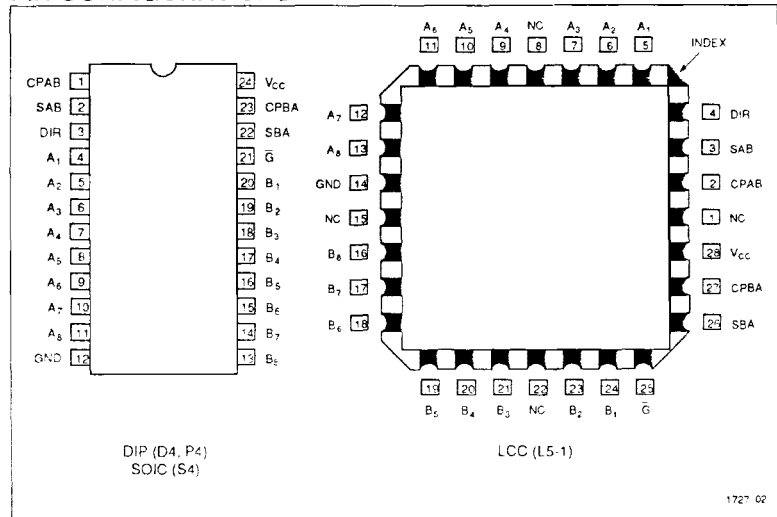

FUNCTIONAL BLOCK DIAGRAM

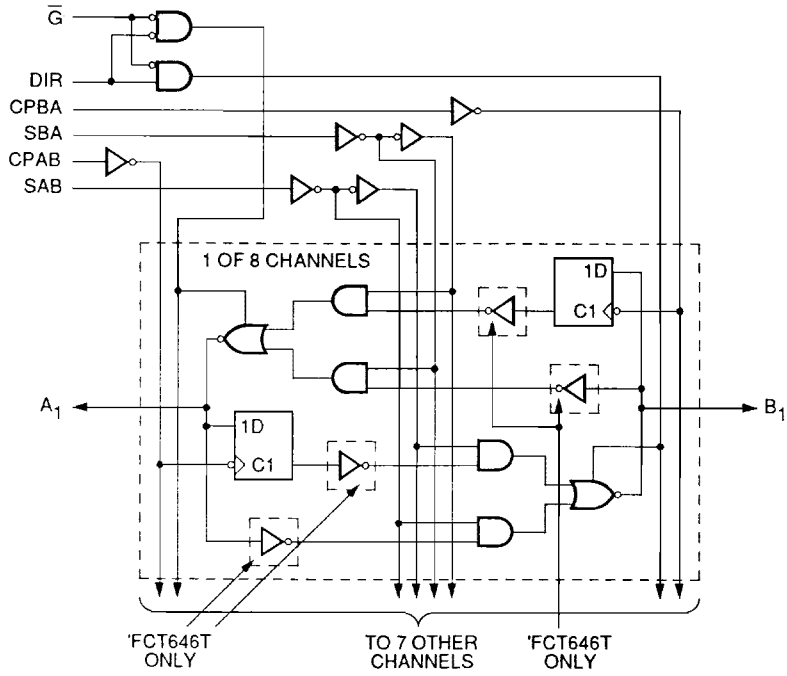

1727 03

PIN DESCRIPTION

Pin Names	Description
A ₁ - A ₈	Data Register A Inputs Data Register B Outputs
B ₁ - B ₈	Data Register B Inputs Data Register A-Outputs
CPAB, CPBA	Clock Pulse Inputs
SAB, SBA	Output Data Source Select Inputs
DIR, G-bar	Output Enable Inputs

1727 Tbl 01

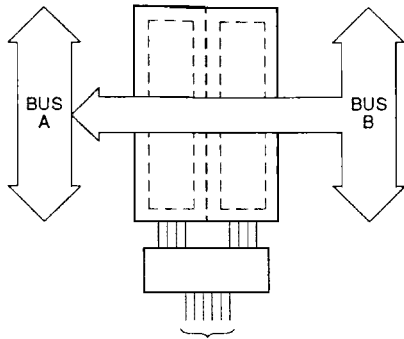

DIR L \bar{G} L CPAB X CPBA X SAB X SBA L

REAL-TIME TRANSFER
BUS B TO BUS A

1727 04

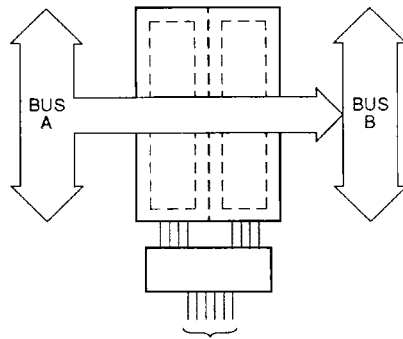

DIR H \bar{G} L CPAB X CPBA X SAB L SBA X

REAL-TIME TRANSFER
BUS A TO BUS B

1727 05

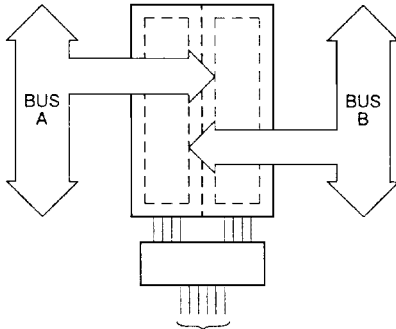

DIR H L X \bar{G} L L H CPAB X X CPBA X X SAB X X X SBA X X X

STORAGE FROM
A AND/OR B

1727 06

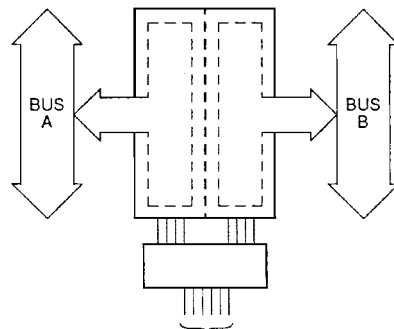

DIR⁽¹⁾ L H \bar{G} L L CPAB X H or L CPBA H or L X SAB X H SBA H X

TRANSFER STORED
DATA TO A AND/OR B

1727 07

Note:
1. Cannot transfer data to A bus and B bus simultaneously.

FUNCTION TABLE

Inputs						Data I/O ¹		Operation or Function	
\bar{G}	DIR	CPAB	CPBA	SAB	SBA	A ₁ thru A ₈	B ₁ thru B ₈	'FCT646T	'FCT648T
H	X	H or L	H or L	X	X	Input	Input	Isolation	Isolation
H	X	\downarrow	\downarrow	X	X			Store A and B Data	Store A and B Data
L	L	X	X	X	L	Output	Input	Real Time B Data to A Bus	Real Time B Data to A Bus
L	L	X	H or L	X	H			Stored B Data to A Bus	Stored B Data to A Bus
L	H	X	X	L	X	Input	Output	Real Time A Data to B Bus	Real Time A Data to B Bus
L	H	H or L	X	H	X			Stored A Data to B Bus	Stored A Data to B Bus

Notes:
1. The data output functions may be enabled or disabled by various signals at the \bar{G} or DIR inputs. Data input functions are always enabled, i.e., data at the bus pins will be stored on every LOW-to-HIGH transition of the clock input. 1727 Tbl 07
2. H = HIGH, L = LOW, X = Don't Care, \downarrow = LOW-to-HIGH Transition. 21352-9

ABSOLUTE MAXIMUM RATINGS^{1,2}

Symbol	Parameter	Value	Unit
T _{STG}	Storage Temperature	-65 to +150	°C
T _A	Ambient Temperature Under Bias	-65 to +135	°C
V _{CC}	V _{CC} Potential to Ground	-0.5 to +7.0	V
P _T	Power Dissipation	0.5	W

1727 Tbl 03

Notes:

1. Operation beyond the limits set forth in the above table may impair the useful life of the device. Unless otherwise noted, these limits are over the operating free-air temperature range.

Symbol	Parameter	Value	Unit
I _{OUTPUT}	Current Applied to Output	120	mA
V _{IN}	Input Voltage	-0.5 to +7.0	V
V _{OUT}	Voltage Applied to Output	-0.5 to +7.0	V

1727 Tbl 04

2. Unused inputs must always be connected to an appropriate logic voltage level, preferably either V_{CC} or ground.

RECOMMENDED OPERATING CONDITIONS

Free Air Ambient Temperature	Min	Max
Military	-55°C	+125°C
Commercial	0°C	+70°C

1727 Tbl 05

Supply Voltage (V _{CC})	Min	Max
Military	+4.5V	+5.5V
Commercial	+4.75V	+5.25V

1727 Tbl 06

DC ELECTRICAL CHARACTERISTICS (Over recommended operating conditions)

Symbol	Parameter	Min	Typ ¹	Max	Units	V _{CC}	Conditions	
V _{IH}	Input HIGH Voltage	2.0			V			
V _{IL}	Input LOW Voltage			0.8	V			
V _H	Hysteresis ³		0.2		V		All inputs	
V _{IK}	Input Clamp Diode Voltage		-0.7	-1.2	V	MIN	I _{IN} = -18mA	
V _{OH}	Output HIGH Voltage	Military	2.4	3.3	V	MIN	I _{OH} = -12mA	
		Commercial	2.4	3.3	V	MIN	I _{OH} = -15mA	
V _{OL}	Output LOW Voltage	Military		0.3	0.55	V	MIN	I _{OL} = 48mA
		Commercial		0.3	0.55	V	MIN	I _{OL} = 64mA
I _I	Input HIGH Current			20	µA	MAX	V _{IN} = V _{CC}	
I _{IH}	Input HIGH Current (Except I/O Pins)			5	µA	MAX	V _{IN} = 2.7V	
I _{IL}	Input LOW Current (Except I/O Pins)			-5	µA	MAX	V _{IN} = 0.5V	
I _{IH}	Input HIGH Current (I/O Pins only)			15	µA	MAX	V _{OUT} = 2.7V	
I _{IL}	Input LOW Current (I/O Pins only)			-15	µA	MAX	V _{OUT} = 0.5V	
I _{OS}	Output Short Circuit Current ²	-60	-120	-225	mA	MAX	V _{OUT} = 0.0V	
I _{OFF}	Power-off Disable			100	µA	0V	V _{OUT} = 4.5V	
C _{IN}	Input Capacitance ³		6	10	pF	MAX	All inputs	
C _{I/O}	I/O Capacitance ³		8	12	pF	MAX	All outputs	
I _{CC}	Quiescent Power Supply Current		0.2	1.5	mA	MAX	V _{IN} < 0.2V, V _{IN} ≥ V _{CC} - 0.2V	

1727 Tbl 07

Notes:

1. Typical limits are at V_{CC} = 5.0V, T_A = +25°C ambient
 2. Not more than one output should be shorted at a time. Duration of short should not exceed one second. The use of high speed test apparatus and/or sample and hold techniques are preferable in order to minimize internal chip heating and more accurately reflect

operational values. Otherwise prolonged shorting of a high output may raise the chip temperature well above normal and thereby cause invalid readings in other parameter tests. In any sequence of parameter tests, I_{OS} tests should be performed last.

3. This parameter is guaranteed but not tested.

DC CHARACTERISTICS (Over recommended operating conditions unless otherwise specified.)

Symbol	Parameter	Typ ¹	Max	Units	Conditions
ΔI_{CC}	Quiescent Power Supply Current (TTL inputs)	0.5	2.0	mA	$V_{CC} = \text{MAX}$, $V_{IN} = 3.4V^2$, $f_1 = 0$, Outputs Open
I_{CCD}	Dynamic Power Supply Current ³	0.15	0.25	mA/ mHz	$V_{CC} = \text{MAX}$, One Input Toggling, 50% Duty Cycle, Outputs Open, $\overline{G} = \text{DIR} = \text{GND}$, or $\overline{GAB} = \text{GBA} = \text{GND}$, $V_{IN} \leq 0.2V$ or $V_{IN} \geq V_{CC} - 0.2V$
I_C	Total Power Supply Current ⁵	1.7	4.0	mA	$V_{CC} = \text{MAX}$, $f_0 = 10\text{MHz}$, 50% Duty Cycle, Outputs Open, One Bit Toggling at $f_1 = 5\text{MHz}$, $\overline{G} = \text{DIR} = \text{GND}$, or $\overline{GAB} = \overline{GBA} = \text{GND}$, $V_{IN} \leq 0.2V$ or $V_{IN} \geq V_{CC} - 0.2V$
		2.2	6.0	mA	$V_{CC} = \text{MAX}$, $f_0 = 10\text{MHz}$, 50% Duty Cycle, Outputs Open, One Bit Toggling at $f_1 = 5\text{MHz}$, $\overline{G} = \text{DIR} = \text{GND}$, or $\overline{GAB} = \overline{GBA} = \text{GND}$, $V_{IN} = 3.4V$ or $V_{IN} = \text{GND}$
		7.0	12.8 ⁴	mA	$V_{CC} = \text{MAX}$, $f_0 = 10\text{MHz}$, 50% Duty Cycle, Outputs Open, Eight Bits Toggling at $f_1 = 5\text{MHz}$, $\overline{G} = \text{DIR} = \text{GND}$, or $\overline{GAB} = \overline{GBA} = \text{GND}$, $V_{IN} \leq 0.2V$ or $V_{IN} \geq V_{CC} - 0.2V$
		9.2	21.8 ⁴	mA	$V_{CC} = \text{MAX}$, $f_0 = 10\text{MHz}$, 50% Duty Cycle, Outputs Open, Eight Bits Toggling at $f_1 = 5\text{MHz}$, $\overline{G} = \text{DIR} = \text{GND}$, or $\overline{GAB} = \overline{GBA} = \text{GND}$, $V_{IN} = 3.4V$ or $V_{IN} = \text{GND}$

Notes:

- Typical values are at $V_{CC} = 5.0V$, +25°C ambient.
- Per TTL driven input ($V_{IN} = 3.4V$); all other inputs at V_{CC} or GND.
- This parameter is not directly testable, but is derived for use in Total Power Supply calculations.
- Values for these conditions are examples of the I_{CC} formula. These limits are guaranteed but not tested.
- $I_C = I_{\text{QUIESCENT}} + I_{\text{INPUTS}} + I_{\text{DYNAMIC}}$
 $I_C = I_{CC} + \Delta I_{CC} D_H N_T + I_{CCD} (f_0/2 + f_1 N_1)$
 I_{CC} = Quiescent Current with CMOS input levels
 ΔI_{CC} = Power Supply Current for a TTL High Input ($V_{IN} = 3.4V$)

 D_H = Duty Cycle for TTL Inputs High N_T = Number of TTL Inputs at D_H I_{CCD} = Dynamic Current Caused by an Input Transition Pair (HLH or LHL) f_0 = Clock Frequency for Register Devices (Zero for Non-Register Devices) f_1 = Input Frequency N_1 = Number of Inputs at f_1

All currents are in milliamps and all frequencies are in megahertz.

1727 Tbl 08

7

AC CHARACTERISTICS

Symbol	Parameter	'FCT646T/648T				'FCT646AT/648AT				'FCT646CT/648CT				Units	Fig. No.
		MIL		COM'L		MIL		COM'L		MIL		COM'L			
		Min.	Max.	Min.	Max.	Min.	Max.	Min.	Max.	Min.	Max.	Min.	Max.		
t_{PLH} t_{PHL}	Propagation Delay Bus to Bus	2.0	11.0	2.0	9.0	2.0	7.7	2.0	6.3	1.5	6.0	1.5	5.4	ns	1, 3
t_{PZH} t_{PZL}	Output Enable Time Enable to Bus and DIR to A or B	2.0	15.0	2.0	14.0	2.0	10.5	2.0	9.8	1.5	8.9	1.5	7.8	ns	1, 7, 8
t_{PHZ} t_{PLZ}	Output Disable Time \bar{G} to Bus and DIR to Bus	2.0	11.0	2.0	9.0	2.0	7.7	2.0	6.3	1.5	7.7	1.5	6.3	ns	1, 7, 8
t_{PLH} t_{PHL}	Propagation Delay Clock to Bus	2.0	10.0	2.0	9.0	2.0	7.0	2.0	6.3	1.5	6.3	1.5	5.7	ns	1, 5
t_{PLH} t_{PHL}	Propagation Delay SBA or SAB to A or B	2.0	12.0	2.0	11.0	2.0	8.4	2.0	7.7	1.5	7.0	1.5	6.2	ns	1, 5

1727 Tbl 09

Note:

1. AC Characteristics guaranteed with $C_L = 50pF$ as shown in Figure 1.

AC OPERATING REQUIREMENTS

Symbol	Parameter	'FCT646T/648T				'FCT646AT/648AT				'FCT646CT/648CT				Units	Fig. No.
		MIL		COM'L		MIL		COM'L		MIL		COM'L			
		Min.	Max.	Min.	Max.	Min.	Max.	Min.	Max.	Min.	Max.	Min.	Max.		
$t_s(H)$ $t_s(L)$	Setup Time HIGH or LOW Bus to Clock	4.5	—	4.0	—	2.0	—	2.0	—	2.0	—	2.0	—	ns	4
$t_h(H)$ $t_h(L)$	Hold Time HIGH or LOW Bus to Clock	2.0	—	2.0	—	1.5	—	1.5	—	1.5	—	1.5	—	ns	4
$t_w(H)$ $t_w(L)$	Pulse Width, HIGH or LOW	6.0	—	6.0	—	5.0	—	5.0	—	5.0	—	5.0	—	ns	5

1727 Tbl 10

Note:

1. Minimum limits are guaranteed but not tested on Propagation Delays

ORDERING INFORMATION

$\frac{PxxFCT}{Temp. Class}$ $\frac{xxxx}{Device type}$ $\frac{x}{Package}$ $\frac{x}{Processing}$

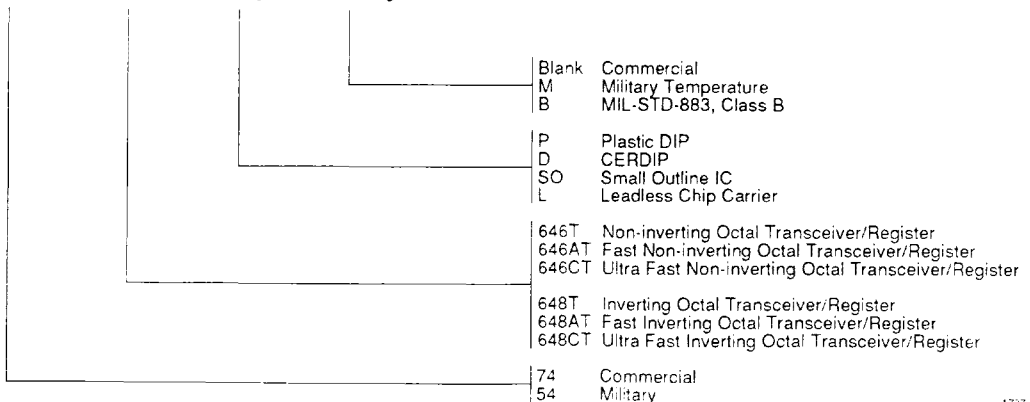

1727 08