

Features

- Analog Signal Range ($\pm 15V$ Supplies) $\pm 15V$
- Low Leakage (Typical @ $+25^{\circ}C$) $40pA$
- Low Leakage (Typical @ $+125^{\circ}C$) $1nA$
- Low On Resistance (Typical @ $+25^{\circ}C$) 35Ω
- Break-Before-Make Delay (Typical) $60ns$
- Charge Injection $30pC$
- TTL, CMOS Compatible
- Symmetrical Switch Elements
- Low Operating Power $1.0mW$
(Typical for HI-300 - 303)

Applications

- Sample and Hold i.e. Low Leakage Switching
- Op Amp Gain Switching i.e. Low On Resistance
- Portable, Battery Operated Circuits
- Low Level Switching Circuits
- Dual or Single Supply Systems

Functional Diagram

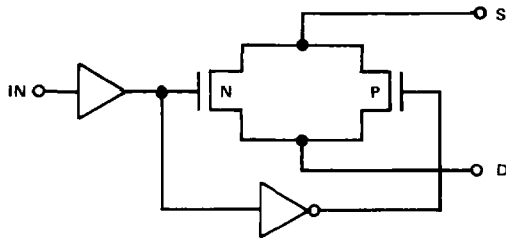

TYPICAL SWITCH 300 SERIES

Description

The HI-300 through HI-307 series of switches are monolithic devices fabricated using CMOS technology and the Harris dielectric isolation process. These switches feature break-before-make switching, (HI-301, 303, 305 & 307 only), low and nearly constant ON resistance over the full analog signal range, and low power dissipation, (a few milliwatts for the HI-300 - 303, a few hundred microwatts for the HI-304 - 307).

The HI-300 - 303 are TTL compatible and have a logic "0" condition with an input less than 0.8V and a logic "1" condition with an input greater than 4.0V. The HI-304 - 307 switches are CMOS compatible and have a low state with an input less than 3.5V and a high state with an input greater than 11V. (See pinouts for switch conditions with a logic "1" input.)

All the devices are available in a 14 pin Epoxy or Ceramic DIP. The HI-300, 301, 304 and 305 are also available in a 10 pin Metal Can. Each of the switch types are available in either the $-55^{\circ}C$ to $+125^{\circ}C$ or $0^{\circ}C$ to $+75^{\circ}C$ operating ranges.

Pinouts (SWITCH STATES ARE FOR A LOGIC "1" INPUT)

DUAL SPST HI-300 & HI-304

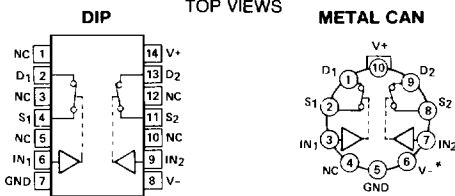

LOGIC	SWITCH
0	OFF
1	ON

* The substrate and case are internally tied to V-. (The case should not be used as the V- connection, however.)

SPDT HI-301 & HI-305

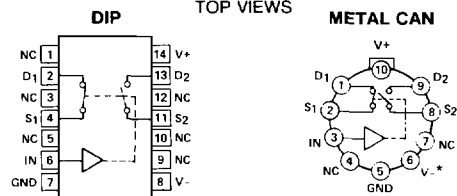

LOGIC	SW 1	SW 2
0	OFF	ON
1	ON	OFF

* The substrate and case are internally tied to V-. (The case should not be used as the V- connection, however.)

DUAL DPST HI-302 & HI-306

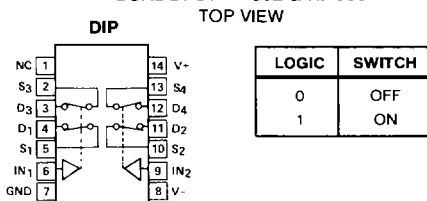

LOGIC	SWITCH
0	OFF
1	ON

DUAL SPDT HI-303 & HI-307

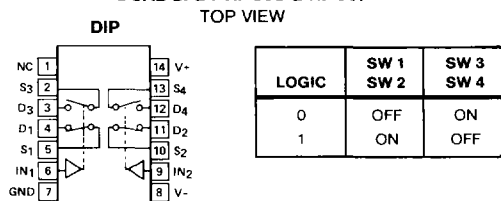

LOGIC	SW 1	SW 2	SW 3	SW 4
0	OFF	OFF	ON	ON
1	ON	ON	OFF	OFF

Specifications HI-300 - HI-307

HI-300 thru HI-307

CMOS ANALOG SWITCHES

3

Absolute Maximum Ratings (Note 1)

Voltage Between Supplies	44V (±22)
Digital Input Voltage	+VSUPPLY +4V -VSUPPLY -4V
Analog Input Voltage	+VSUPPLY +1.5V -VSUPPLY -1.5V
Total Power Dissipation*	14 Pin Epoxy DIP 526mW 14 Pin Ceramic DIP 588mW 10 Pin Metal Can* 435mW

Operating Temperature Range

HI-3XX-2	-55°C to +125°C
HI-3XX-5	0°C to +75°C
Storage Temperature	-65°C to +150°C

*Derate 6.9mW/0°C Above T_A = +70°C

Electrical Specifications Unless Otherwise Specified: Supplies = +15V, -15V; V_{IN} = Logic Input.

HI-300-303: V_{IN} - for Logic "1" = 4V, for Logic "0" = 0.8V

HI-304-307: V_{IN} - for Logic "1" = 11V, for Logic "0" = 3.5V

PARAMETER	TEMP	-55°C To +125°C			0°C To +75°C			UNITS
		MIN	TYP	MAX	MIN	TYP	MAX	
ANALOG SWITCH CHARACTERISTICS								
Analog Signal Range	Full	-15	-	+15	-15	-	+15	V
R _{ON} , On Resistance (Note 2)	+25°C	-	35	50	-	35	50	Ω
	Full	-	40	75	-	40	75	Ω
I _{S(OFF)} , Off Input Leakage Current (Note 3)	+25°C	-	0.04	1	-	0.04	5	nA
	Full	-	1	100	-	0.2	100	nA
I _{D(OFF)} , Off Output Leakage Current (Note 3)	+25°C	-	0.04	1	-	0.04	5	nA
	Full	-	1	100	-	0.2	100	nA
I _{D(ON)} , On Leakage Current (Note 4)	+25°C	-	0.03	1	-	0.03	5	nA
	Full	-	0.5	100	-	0.2	100	nA
DIGITAL INPUT CHARACTERISTICS								
V _{INL} , Input Low Level*	Full	-	-	0.8	-	-	0.8	V
V _{INH} , Input High Level*	Full	4	-	-	4	-	-	V
V _{INL} , Input Low Level**	Full	-	-	3.5	-	-	3.5	V
V _{INH} , Input High Level**	Full	11	-	-	11	-	-	V
I _{INL} , Input Leakage Current (Low) (Note 5)	Full	-	-	1	-	-	1	μA
I _{INH} , Input Leakage Current (High) (Note 5)	Full	-	-	1	-	-	1	μA
SWITCHING CHARACTERISTICS								
t _{OPEN} , Break-Before Make Delay***	+25°C	-	60	-	-	60	-	ns
t _{ON} , Switch On Time*	+25°C	-	210	300	-	210	300	ns
t _{OFF} , Switch Off Time*	+25°C	-	160	250	-	160	250	ns
t _{ON} , Switch Off Time**	+25°C	-	160	250	-	160	250	ns
t _{OFF} , Switch Off Time**	+25°C	-	100	150	-	100	150	ns
"Off Isolation" (Note 6)	+25°C	-	60	-	-	60	-	dB
Charge Injection (Note 7)	+25°C	-	3	-	-	3	-	mV
C _{S(OFF)} , Input Switch Capacitance	+25°C	-	16	-	-	16	-	pF
C _{D(OFF)} , Output Switch Capacitance	+25°C	-	14	-	-	14	-	pF
C _{D(ON)} , Output Switch Capacitance	+25°C	-	35	-	-	35	-	pF
C _{IN} , (High) Digital Input Capacitance	+25°C	-	5	-	-	5	-	pF
C _{IN} , (Low) Digital Input Capacitance	+25°C	-	5	-	-	5	-	pF
POWER REQUIREMENTS								
I ⁺ , Current* (Note 8)	+25°C	-	0.09	0.5	-	0.09	0.5	mA
	Full	-	-	1	-	-	1	mA
I ⁻ , Current* (Note 8)	+25°C	-	0.01	10	-	0.01	100	μA
	Full	-	-	100	-	-	-	μA
I ⁺ , Current* (Note 9)	+25°C	-	0.01	10	-	0.01	100	μA
	Full	-	-	100	-	-	-	μA
I ⁻ , Current* (Note 9)	+25°C	-	0.01	10	-	0.01	100	μA
	Full	-	-	100	-	-	-	μA
I ⁺ , Current** (Note 10)	+25°C	-	0.01	10	-	0.01	100	μA
	Full	-	-	100	-	-	-	μA
I ⁻ , Current** (Note 10)	+25°C	-	0.01	10	-	0.01	100	μA
	Full	-	-	100	-	-	-	μA
I ⁺ , Current** (Note 11)	+25°C	-	0.01	10	-	0.01	100	μA
	Full	-	-	100	-	-	-	μA
I ⁻ , Current** (Note 11)	+25°C	-	0.01	10	-	0.01	100	μA
	Full	-	-	100	-	-	-	μA

*HI-300 Thru HI-303 Only; **HI-304 Thru HI-307 Only; ***HI-301, HI-303, HI-305, HI-307 Only

Electrical Specifications Notes:

1. As with all semiconductors, stresses listed under "Absolute Maximum Ratings" may be applied to devices (one at a time) without resulting in permanent damage. This is a stress rating only. Exposure to absolute maximum rating conditions for extended periods may affect device reliability. The conditions listed under "Electrical Specifications" are the only conditions recommended for satisfactory operation.
2. $V_S = \pm 10V$, $I_{OUT} = -10mA$. On resistance derived from the voltage measured across the switch under the above conditions.
3. $V_S = \pm 14V$, $V_D = \pm 14V$.
4. $V_S = V_D = \pm 14V$.
5. The digital inputs are diode protected MOS gates and typical leakages of 1nA or less can be expected.
6. $V_S = 1V_{RMS}$, $f = 500kHz$, $C_L = 15pF$, $R_L = 1k$.
7. $V_S = 0V$, $C_L = 10,000pF$. Logic Drive = 5V pulse. (HI-300 - 303) Switches are symmetrical; S and D may be interchanged. Logic Drive = 15V (HI-304 - 307).
8. $V_{IN} = 4V$ (One Input) (All Other Inputs = 0V).
9. $V_{IN} = 0.8V$ (All Inputs).
10. $V_{IN} = 15V$ (All Inputs).
11. $V_{IN} = 0V$ (All Inputs).
12. To drive from DTL/TTL circuits, pull-up resistors to +5V supply are recommended.

Test Circuits

SWITCHING TEST CIRCUIT (t_{ON} , t_{OFF})

SWITCH TYPE	V_{INH}
HI-300 thru HI-303	4V
HI-304 thru HI-307	15V

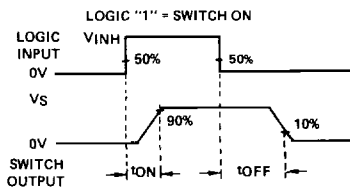
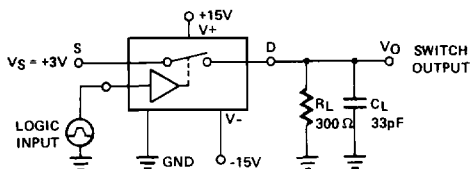

BREAK-BEFORE-MAKE TEST CIRCUIT (t_{BBM})

SWITCH TYPE	V_{INH}
HI-301, HI-303	5V
HI-305, HI-307	15V

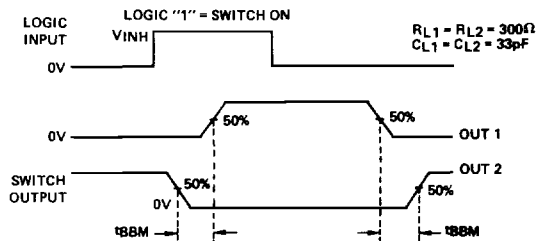
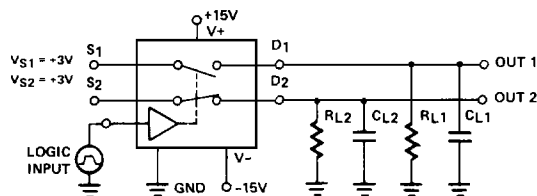

Typical Performance Curves

R_{DS(ON)} VS. V_D AND TEMPERATURE

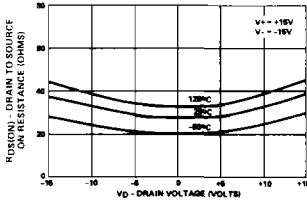

R_{DS(ON)} VS. V_D AND POWER SUPPLY VOLTAGE

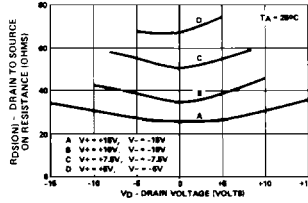

DEVICE POWER DISSIPATION VS. SWITCHING FREQUENCY SINGLE LOGIC INPUT

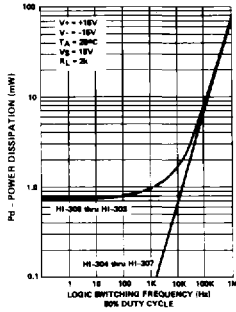

OFF ISOLATION VS. FREQUENCY

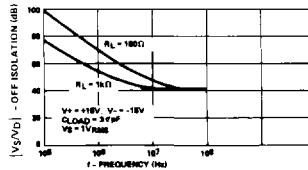

I_{S(OFF)} OR I_{D(OFF)} VS. TEMPERATURE *

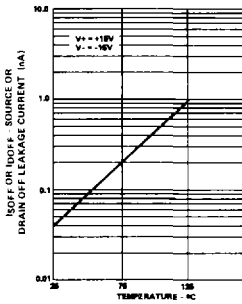

I_{D(ON)} VS. TEMPERATURE *

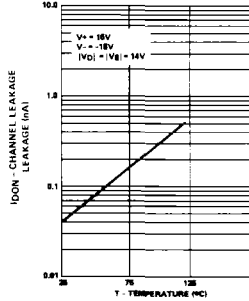

* The net leakage into the source or drain is the n-channel leakage minus the p-channel leakage. This difference can be positive, negative, or zero depending on the analog voltage and temperature, and will vary greatly from unit to unit.

OUTPUT ON CAPACITANCE VS. DRAIN VOLTAGE

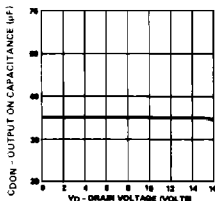

DIGITAL INPUT CAPACITANCE VS. INPUT VOLTAGE

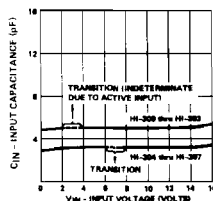

Typical delay, rise, fall, setting times, and switching transients in this circuit.

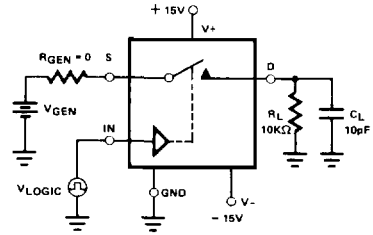

If R_{GEN}, R_L or C_L is increased, there will be proportional increases in rise and/or fall RC times.

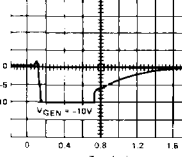
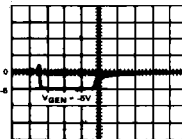
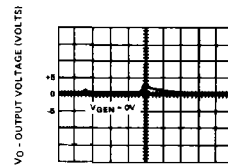
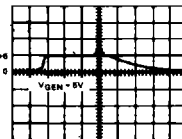
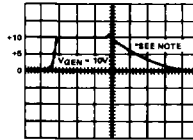
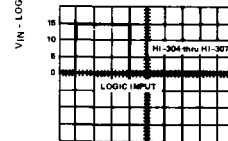
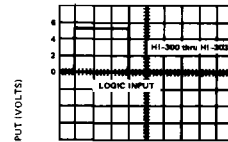

Typical Performance Curves (Continued)

SWITCHING TIME VS. TEMPERATURE
HI-300 thru HI-303

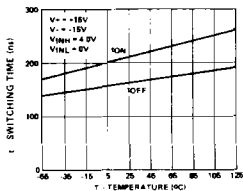

SWITCHING TIME VS. TEMPERATURE
HI-304 thru HI-307

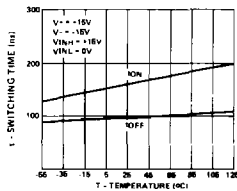

SWITCHING TIME VS. NEGATIVE SUPPLY VOLTAGE
HI-300 thru HI-303

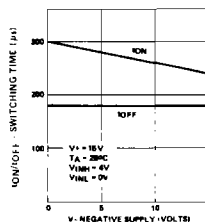

SWITCHING TIME AND BREAK BEFORE MAKE TIME VS. POSITIVE SUPPLY VOLTAGE
HI-300 thru HI-303

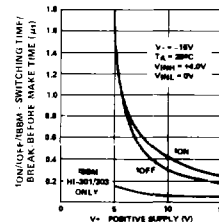

SWITCHING TIME VS. POSITIVE SUPPLY VOLTAGE
HI-304 thru HI-307

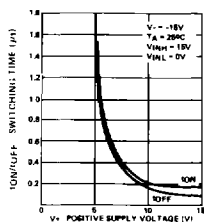

SWITCHING TIME VS. NEGATIVE SUPPLY VOLTAGE
HI-304 thru HI-307

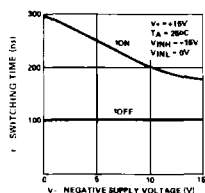

INPUT SWITCHING THRESHOLD VS. POSITIVE SUPPLY VOLTAGE
HI-300 thru HI-307

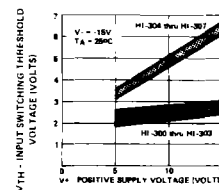

Schematic Diagrams

SWITCH CELL

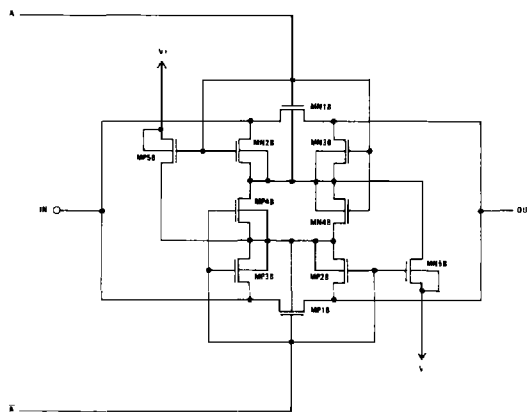

DIGITAL INPUT BUFFER AND LEVEL SHIFTER

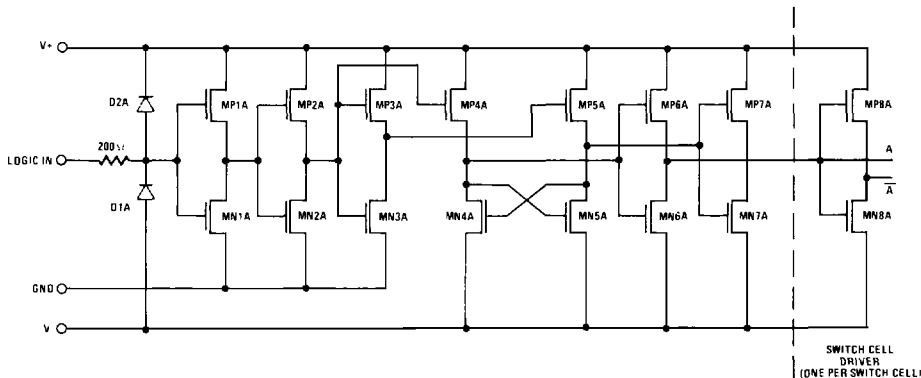

SWITCH CELL DRIVER (ONE PER SWITCH CELL)