



# Mini size of Discrete semiconductor elements



## Diode Rectifier

→	Schottky SOD-723 / SOD-523 / SOD-323	-----	P1
→	TO-252 / TO263		
→	SOT-23-6 / TSSOP-8 / SOP-8		
→	mini-MELF / MELF		
→	SMA / SMB / SMC		
→	Switching SOT-523 / SOT-323 / SOT-23	-----	P2
→	Bridge (Single phase / Three phase)	-----	P3
→	RF ( low capacitance ) & Varactor	-----	P4



## MOSFET

→	SOT-323	-----	P5
→	SOT-23		
→	TO-252 / TO-263 / TO-220 / TO-3P	-----	P6
→	TSSOP-8 / SOP-8		



## Regulator

→	Switching Regulator / Charger pump	-----	P7
→	DC-DC converter / PWM IC	-----	P8
→	Step-up/down (Boost / Buck)		
→	LDO Regulator	-----	P9~
→	Ultra LDO Regulator	-----	P11



## Transistor (Digital)

→	SOT-323 / SOT-363 (Dual N , Dual P , P+N)	-----	P12
→	SOT-23 / SOT-89	-----	P13
→	TO-252 / TO-263	-----	P14
→	TO-92 / TO-220 / TO-3P	-----	P15
→	Triac / SCR / RF (1GHz ~ )		
→	Digital	-----	P16~
			P18



## Reset IC

→	SOT-23 / SOT-23-5	-----	P19
→	SOT-89 / TO-92		

## Logic IC

→	SOT-23-5 / SOT-323-5	-----	P20
→	Standard		

## EEPROM IC



## Protection Device

→	Sidac / Thyristor / EMI Filter	-----	P21
→	TVS / ESD Arrays / Varistor (chip)	-----	P22
→	Gastube arrester / 5~6 pin arrester	-----	P23
→	Polymer resetable fuse / Thermal switch & sensor	-----	P24

## Film Capacitor

→	Class X1 / X2 Safety license (300Vac)	-----	P25
→	MPP / MPE / DMP (High current)		
→	Minibox DC film cap. / <u>X+Y</u> combint cap.	-----	P26
→	Lighting film / AC starting film cap.		



## Ceramic Cap.

→	Class Y1 / Y2 Safety license	-----	P27
→	High voltage (1KV ~ 6KV)		
→	Chip Capacitors & Multilayer (MLCC)		
→	Tantalum Capacitors		



## Package Outline Dimensions

----- P28 ~ P34

**\*Other Industrial specification ( -20°C / -30°C / - 40°C ~ 85°C )**

# Transistors

Part Number	NPN or PNP	Maximum Ratings				Electrical Characteristics (Ta=25°C)							fT MHz	PIN
		BVCBO (V)	BVCEO (V)	IC (mA)	PD Ta=25°C (mW)	hFE				VCE(sat)				
						Min	Max	IC (mA)	VCE (V)	Max (V)	IC (mA)	IB (mA)		
<b>SOT-323 (P.28)</b>														
BC846W	NPN	80	65	100	225	110	800	2	5	0.25	10	0.5	300	BCE
BC847W	NPN	50	45	100	225	110	800	2	5	0.25	10	0.5	300	BCE
MMBT2222AW	NPN	75	40	600	225	100	300	150	10	0.5	380	10	300	BCE
MMBT2907AW	PNP	-60	-60	-600	225	100	300	-150	-10	-0.4	-150	-15	200	BCE
MMBT3904W	NPN	60	40	200	225	100	300	10	1	0.2	10	1	300	BCE
MMBT3906W	PNP	-40	-40	-200	225	120	360	-10	-1	0.25	-10	-1	250	BCE
*MMBT5401W	PNP	-160	-150	-600	225	60	240	-10	-5	-0.2	-10	-1	100	BCE
*MMBT5551W	NPN	180	160	600	225	80	250	10	5	0.15	10	1	100	BCE
<b>SOT-363 (P.29)</b>														
MMDT2412	N*2	50	40	150	200	120	820	1	6	0.4	1	5	180	DAUL
MMDT3904	N*2	60	40	200	200	100	300	10	1	0.2	10	1	300	DAUL
MMDT2222	N*2	75	40	600	200	100	300	150	10	0.5	150	10	300	DAUL
MMDT2411	N*2	40	40	600	200	82	560	100	3	0.4	100	10	300	DAUL
MMDT1036	P*2	-40	-32	500	200	100	300	-150	-10	-0.4	-150	-15	200	DAUL
MMDT1037	P*2	-60	-50	150	200	120	820	-1	-6	-0.5	-1	-5	140	DAUL
MMDT3906	P*2	-40	-40	200	200	100	300	-10	-1	-0.25	-10	-1	250	DAUL
MMDT2907	P*2	-60	-60	600	200	100	300	-150	-10	-0.4	-150	-15	200	DAUL
MMDT2227	N+P	75	40	600	200	100	300	150	10	0.3	150	15	300	N+P
		-60	-60	600	200	100	300	-150	-10	-0.4	-150	-15	200	
MMDT3946	N+P	60	40	200	200	100	300	10	1	0.2	10	1	300	N+P
		-40	-40	200	200	100	300	-10	-1	-0.25	-10	-1	250	
<b>SOT-23 (P.28)</b>														
BC807	PNP	-50	-45	-800	225	100	630	-100	-1	-0.7	-500	-50	100	BCE
BC817	NPN	50	45	800	225	100	630	100	1	0.7	500	50	100	BCE
BC846	NPN	80	65	100	225	110	800	2	5	0.25	10	0.5	300	BCE
BC847	NPN	50	45	100	225	110	800	2	5	0.25	10	0.5	300	BCE
BC848	NPN	30	30	100	225	110	800	2	5	0.25	10	0.5	300	BCE
BC856	PNP	-80	-65	-100	225	115	800	-2	-5	-0.3	-10	-0.5	150	BCE
BC857	PNP	-50	-45	-100	225	110	800	-2	-5	-0.3	-10	-0.5	150	BCE
BC858	PNP	-30	-30	-100	225	110	800	-2	-5	-0.3	-10	-0.5	150	BCE
BCW65C	NPN	60	32	800	225	250	630	100	1	0.3	100	10	170	BCE
MMBT1015	PNP	-50	-50	-150	225	120	700	-2	-6	-0.3	-100	-10	80	BCE
MMBT1815	NPN	60	50	150	225	120	700	2	6	0.25	100	10	80	BCE
MMBT2222A	NPN	75	40	600	225	100	300	150	10	0.5	380	10	300	BCE
MMBT2369	NPN	40	40	500	225	40	120	10	1	0.25	10	1	500	BCE
MMBT2484	NPN	60	60	50	225	250	-	1	5	0.35	1	0.1		BCE
MMBT2907A	PNP	-60	-60	-600	225	100	300	-150	-10	-0.4	-150	-15	200	BCE
MMBT3904	NPN	60	40	200	225	100	300	10	1	0.2	10	1	300	BCE
MMBT3906	PNP	-40	-40	-200	225	120	360	-10	-1	0.25	-10	-1	250	BCE
MMBT4124	NPN	30	25	200	225	120	360	2	1	0.3	50	5	300	BCE
MMBT4125	PNP	-30	-30	-200	225	50	150	-2	-1	-0.4	-50	-5	200	BCE
MMBT4401	NPN	60	40	600	225	100	300	150	1	0.4	150	15	250	BCE
MMBT4403	PNP	-40	-40	-600	225	100	300	-150	-2	-0.4	-150	-15	200	BCE
MMBT5086	PNP	-50	-50	-50	225	150	500	-0.1	-5	-0.3	-10	-1	40	BCE
MMBT5087	PNP	-50	-50	-50	225	250	800	-0.1	-5	-0.3	-10	-1	40	BCE
MMBT5088	NPN	35	30	50	225	300	900	0.1	5	0.5	10	1	50	BCE
MMBT5089	NPN	30	25	50	225	400	1200	0.1	5	0.5	10	1	50	BCE
MMBT5401	PNP	-160	-150	-600	225	60	240	-10	-5	-0.2	-10	-1	100	BCE
MMBT5550	NPN	160	140	600	225	60	250	10	5	0.25	50	5	100	BCE
MMBT5551	NPN	180	160	600	225	80	250	10	5	0.15	10	1	100	BCE
MMBT6427	NPN	40	40	500	225	20K	200K	100	5	1.2	50	0.5		BCE
MMBT6429	NPN	55	45	200	225	500	1250	0.1	5	0.2	10	0.5	100	BCE
MMBT6517	NPN	350	350	500	225	30	200	30	10	0.5	30	3	40	BCE
MMBT6520	PNP	-350	-350	-500	225	30	200	-30	-10	-0.5	-30	-3	40	BCE
MMBT8050	NPN	25	20	700	225	150	500	150	1	0.5	500	50	150	BCE
MMBT8099	NPN	80	80	500	225	100	300	1	5	0.4	100	5	150	BCE
MMBT8550	PNP	-25	-20	-700	225	150	400	-150	-1	-0.5	-500	-50	150	BCE
MMBT8599	PNP	-80	-80	-500	225	100	300	-1	-5	-0.4	-100	-5	150	BCE
MMBT9018	NPN	20	15	50	225	30	400	1	6	0.5	5	0.5	500	BCE
MMBTA06	NPN	80	80	500	225	50	-	10	1	0.25	100	10	100	BCE
MMBTA13	NPN	30	30	300	225	10K	-	100	5	1.5	100	0.1	125	BCE
MMBTA14	NPN	30	30	300	225	20K	-	100	5	1.5	100	0.1	125	BCE

Part Number	NPN or PNP	Maximum Ratings				Electrical Characteristics (Ta=25°C)							fT MHz	PIN
		BVCBO	BVCEO	IC	PD Ta=25°C	hFE				VCE(sat)				
		(V)	(V)	(mA)	(mW)	Min	Max	IC (mA)	VCE (V)	Max (V)	IC (mA)	IB (mA)		
<b>SOT-23 (P.28)</b>														
MMBTA42	NPN	300	300	500	225	40	-	10	10	0.5	20	2	50	BCE
MMBTA44	NPN	450	400	300	350	50	300	10	10	0.4	1	0.1		BCE
MMBTA56	PNP	-80	-80	-500	225	50	-	-100	-1	-0.25	-100	-10	100	BCE
MMBTA64	PNP	-30	-30	-500	225	20K	-	-100	-5	-1.5	-100	-0.1	125	BCE
MMBTA92	PNP	-300	-300	-500	225	40	-	-10	-10	-0.5	-20	-2	50	BCE
MMBTA94	PNP	-400	-400	-150	350	75	200	-10	-10	-0.2	-1	-0.1		BCE
MMBTH10	NPN	20	15	50	225	60	-	4	10	0.5	4	0.4	650	BCE
GT85C	NPN	50	45	800	225	100	630	100	1	0.7	500	50	100	BCE
GTD82NS	NPN	40	30	3000	1000	30	400	1	2	0.5	2	0.2	80	BCE
GTB72PS	PNP	-40	-30	-3000	1000	30	400	-1	-2	-0.5	-2	-0.2	80	BCE
SC5094	NPN	18	10	20	150	50	200	1	2	-	-	-	9000	BCE
<b>SOT-89 (P.32)</b>														
M1300	PNP	-20	-10	-2000	1	140	1000	-500	-1	-0.5	-2000	-50	140	BCE
M14	NPN	30	30	300	1	20K	-	100	5	1.5	100	0.1	125	BCE
M1426	PNP	-20	-20	-3000	1.2	160	390	-100	-2	-0.5	-2000	-100	240	BCE
M2222A	NPN	75	40	600	1.2	100	300	150	10	0.3	150	15	300	BCE
M27	NPN	60	60	500	1	10K	-	100	5	1.5	100	0.1		BCE
M2907A	PNP	-60	-60	-600	1.2	100	300	-150	-10	-0.4	-150	-15	200	BCE
M3019	NPN	140	80	1000	1.2	100	300	150	10	0.2	150	15	100	BCE
M3669	NPN	80	80	2000	1	300	-	500	2	0.5	1000	50	100	BCE
M3904	NPN	60	40	200	1	100	300	10	1	0.3	50	5	300	BCE
M3906	PNP	-40	-40	-200	1	100	300	-10	-1	-0.4	-50	-5	250	BCE
M4033	PNP	-80	-80	-1000	1.2	100	-	-100	-5	-0.5	-500	-50	100	BCE
M42	NPN	300	300	500	1	40	-	10	10	0.5	20	2	50	BCE
M44	NPN	400	400	300	1	50	300	10	10	0.38	20	2		BCE
M5401	PNP	-160	-150	-600	1	60	240	-10	-5	-0.5	-50	-5	100	BCE
M5551	NPN	180	160	600	1.2	80	250	10	5	0.2	50	5	100	BCE
M64	PNP	-30	-30	-500	1	10K	-	-10	-5	-1.5	-100	-0.1	125	BCE
M6718	NPN	100	100	1000	1	100	250	250	1	0.35	350	35	50	BCE
M772	PNP	-40	-30	-3000	1.5	100	500	-1000	-2	-0.5	-2000	-200	80	BCE
M772A	PNP	-60	-50	-3000	1.5	100	500	-1000	-2	0.5	-2000	-200	80	BCE
M879	NPN	30	10	3000	1	140	400	3000	2	0.4	3000	60	200	BCE
M882	NPN	40	30	3000	1.5	100	500	1000	2	0.5	2000	200	90	BCE
M92	PNP	-300	-300	-500	1	40	-	-10	-10	-0.5	-20	-2	50	BCE
M92M	PNP	-300	-300	-800	1	80	-	-10	-10	-0.7	-100	-10	50	BCE
M94	PNP	-400	-400	-500	1	50	300	-10	-10	-0.5	-10	-1		BCE
M965	NPN	40	20	5000	1.2	340	800	500	2	0.35	3000	100	150	BCE
<b>TO-92 (P.31)</b>														
2N3417	NPN	50	50	500	625	180	540	2	4.5	0.3	50	3		EBC
2N3904	NPN	60	40	200	625	100	300	10	1	0.2	10	1	300	EBC
2N3906	PNP	-40	-40	-200	625	100	300	-10	-1	-0.25	-10	-1	250	EBC
2N4124	NPN	30	25	200	350	120	360	2	1	0.3	50	5	300	EBC
2N4126	PNP	-25	-25	-200	625	120	360	-2	-1	-0.4	-50	-5	250	EBC
2N4401	NPN	60	40	600	625	100	300	150	1	0.4	150	15	250	EBC
2N4403	PNP	-40	-40	-600	625	100	300	-150	-2	-0.4	-150	-15	200	EBC
2N5086	PNP	-50	-50	-50	350	150	500	-0.1	-5	-0.3	-10	-1	40	EBC
2N5087	PNP	-50	-50	-50	625	250	800	-0.1	-5	-0.3	-10	-1	40	EBC
2N5088	NPN	35	30	50	350	300	900	0.1	5	0.5	10	1	50	EBC
2N5089	NPN	30	25	50	350	400	1200	0.1	5	0.5	10	1	50	EBC
2N5366	PNP	-40	-40	-500	400	100	-	-50	-1	-0.25	-50	-5		ECB
2N5401	PNP	-160	-150	-600	625	80	400	-10	-5	-0.2	-10	-1	100	EBC
2N5551	NPN	180	160	600	625	80	400	10	5	0.2	50	5	100	ECB
2N6426	NPN	40	40	500	625	20K	200K	500	5	1.5	500	0.5		EBC
2N6427	NPN	40	40	500	625	10K	100K	10	5	1.2	50	0.5		EBC
2N6517	NPN	350	350	500	625	30	200	30	10	0.3	10	1	40	EBC
2N6520	PNP	-350	-350	-500	625	30	200	-30	-10	-0.3	-10	-1	40	EBC
2N6718L	NPN	100	100	1000	850	50	300	250	1	0.35	350	35	50	ECB
A3669	NPN	80	80	2000	750	240	-	500	2	0.5	1000	50	100	ECB
A8050	NPN	40	25	1500	1000	85	500	100	1	0.5	800	80	100	EBC
A8050S	NPN	25	20	700	625	100	500	150	1	0.5	500	50	150	EBC
A8550	PNP	-40	-25	-1500	1000	85	500	-100	-1	-0.5	-800	-80	100	EBC
A8550S	PNP	-25	-20	-700	625	100	500	-150	-1	-0.5	-500	-50	150	EBC
AD825	NPN	80	55	600	625	10K	100K	100	5	1.5	100	0.1	125	BCE
AD826	NPN	75	60	600	625	100	300	150	10	1	500	50	300	BCE

Part Number	NPN or PNP	Maximum Ratings				Electrical Characteristics (Ta=25°C)							fT MHz	PIN
		BVCEO (V)	BVCEO (V)	IC (mA)	PD Ta=25°C (mW)	hFE				VCE(sat)				
						Min	Max	IC (mA)	VCE (V)	Max (V)	IC (mA)	IB (mA)		
<b>TO-92 (P.31)</b>														
BC237	NPN	50	45	100	400	120	800	2	5	0.2	10	0.5	150	CBE
BC327	PNP	-50	-45	-500	625	100	600	-100	-1	-0.7	-500	-50	100	CBE
BC337	NPN	50	45	800	625	100	600	100	1	0.7	500	50	210	CBE
BC546	NPN	80	65	100	625	110	800	2	5	0.25	10	0.5	300	CBE
BC547	NPN	50	45	100	625	110	800	2	5	0.25	10	0.5	300	CBE
BC548	NPN	30	30	100	400	110	800	2	5	0.6	100	5		CBE
BC556	PNP	-80	-65	-100	500	75	475	-2	-5	-0.3	-10	-0.5	300	CBE
BC557	PNP	-50	-45	-100	500	75	800	-2	-5	-0.3	-10	-1	300	CBE
BC558	PNP	-30	-25	-100	500	75	885	-2	-5	-0.3	-10	-1	300	CBE
BF422	NPN	250	250	50	830	50	-	25	20	0.6	30	3	60	ECB
BF423	PNP	-250	-250	-50	830	50	-	-25	-20	-0.6	-30	-3	60	ECB
DY227	NPN	30	25	300	400	70	400	50	1	0.4	300	30		EBC
E8050	NPN	40	25	1500	1000	85	500	100	1	0.5	800	80	100	ECB
E8050S	NPN	25	20	700	625	100	500	150	1	0.5	500	50	150	ECB
E8051	NPN	40	25	1500	1000	85	500	100	1	0.5	800	80	100	EBC
E8051S	NPN	25	20	700	625	100	500	150	1	0.5	500	50	150	EBC
E8550	PNP	-40	-25	-1500	1000	85	500	-100	-1	-0.5	-800	-80	100	ECB
E8550S	PNP	-25	-20	-700	625	100	500	-150	-1	-0.5	-500	-50	150	ECB
E8551	PNP	-40	-25	-1500	1000	85	500	-100	-1	-0.5	-800	-80	100	EBC
E8551S	PNP	-25	-20	-700	625	100	500	-150	-1	-0.5	-500	-50	150	EBC
E9012	PNP	-40	-20	-500	625	112	300	-50	-1	-0.6	-500	-50	100	EBC
E9013	NPN	40	20	500	625	112	300	50	1	0.6	500	50	100	EBC
E9014	NPN	50	45	100	450	100	1000	1	5	0.14	100	5	150	EBC
E9015	PNP	-50	-45	-100	450	100	600	-1	-5	-0.2	-100	-5	100	EBC
E9018	NPN	30	15	50	-	39	198	1	5	0.5	10	1	700	EBC
LB120A	NPN	600	400	100	625	10	36	50	10	0.4	50	10		ECB
M28S	NPN	40	20	1250	850	300	1000	100	1	0.55	600	20		ECB
MPS650	NPN	60	40	2000	625	75	-	500	2	0.5	2000	200	75	EBC
MPS651	NPN	80	60	2000	625	75	-	500	2	0.5	2000	200	75	EBC
MPS6562	PNP	-25	-25	-500	625	50	200	-500	-1	-0.5	-500	-50	60	EBC
MPS751	PNP	-80	-60	-2000	625	75	-	-500	-2	-0.5	-2000	-200	75	EBC
MPS8099	NPN	80	80	500	625	100	300	1	5	0.4	100	5		EBC
MPS8599	PNP	-80	-80	-500	625	100	300	-1	-5	-0.4	-100	-5	150	EBC
MPSA05	NPN	60	60	500	625	50	-	100	1	0.25	100	10	100	EBC
MPSA06	NPN	80	80	500	625	50	-	100	1	0.25	100	10	100	EBC
MPSA13	NPN	30	30	500	600	10K	-	100	5	1.5	100	0.1	125	EBC
MPSA14	NPN	30	30	500	625	20K	-	100	5	1.5	100	0.1	125	EBC
MPSA18	NPN	45	45	200	625	500	1500	10	5	0.3	50	5	100	EBC
MPSA26	NPN	50	50	500	625	10K	-	10	5	1.5	100	0.1		EBC
MPSA27	NPN	60	60	500	625	10K	-	100	5	1.5	100	0.1		EBC
MPSA42	NPN	300	300	500	625	40	-	10	10	0.35	20	2		EBC
MPSA42M	NPN	300	300	800	625	80	-	10	10	0.2	20	2	50	EBC
MPSA43	NPN	200	200	500	625	40	-	10	10	0.35	20	2	50	EBC
MPSA44	NPN	400	400	300	625	50	300	10	10	0.35	1	0.1		EBC
MPSA55	PNP	-60	-60	-500	625	50	-	-100	-1	-0.25	-100	-10	50	EBC
MPSA56	PNP	-80	-80	-500	625	50	-	-100	-1	-0.25	-100	-10	50	EBC
MPSA64	PNP	-30	-30	-500	625	10K	-	-10	-5	-1.5	-100	-0.1	125	EBC
MPSA92	PNP	-300	-300	-500	625	40	-	-10	-10	-0.35	-20	-2	50	EBC
MPSA92M	PNP	-300	-300	-800	625	80	-	-10	-10	-0.15	-30	-1	50	EBC
MPSA93	PNP	-200	-200	-500	625	40	-	-10	-10	-0.35	-20	-2	50	EBC
MPSA94	PNP	-400	-400	-500	625	50	300	-10	-10	-0.5	-10	-1		EBC
MPSH10	NPN	20	15	50	625	60	-	4	10	0.5	4	0.4	650	BEC
PH2369	NPN	40	15	500	625	40	120	10	1	0.25	10	1	500	CBE
PN2222A	NPN	75	40	600	625	100	300	150	10	0.3	150	15	300	EBC
PN2369A	NPN	40	40	200	625	40	120	10	0.35	0.2	10	1	500	EBC
PN2907A	PNP	-60	-60	-600	625	100	300	-150	-10	-0.4	-150	-15	200	EBC
SA1015	PNP	-50	-50	-150	400	120	700	-2	-6	-0.3	-100	-10	270	ECB
SA1300	PNP	-20	-10	-2000	750	140	1000	-500	-1	-0.5	-2000	-50	140	ECB
SA1538S	PNP	-120	-120	-200	900	60	320	-10	-10	-1	-30	-3	400	ECB
SA733	PNP	-60	-50	-100	250	90	600	-1	-6	-0.18	-100	-10	100	ECB
SB1109S	PNP	-160	-160	-100	900	60	320	-10	-5	-2	-30	-3	140	ECB
SB1426	PNP	-20	-20	-3000	750	82	390	-100	-2	-0.5	-2000	-100	240	ECB
SB562	PNP	-25	-20	-1000	900	85	240	-500	-2	-0.5	-800	-80	350	ECB
SB564A	PNP	-30	-25	-1000	800	70	400	-100	-1	-0.5	-1000	-100	110	ECB

Part Number	NPN or PNP	Maximum Ratings				Electrical Characteristics (Ta=25°C)							fT MHz	PIN
		BVCEO (V)	BVCEO (V)	IC (mA)	PD Ta=25°C (mW)	hFE				VCE(sat)				
						Min	Max	IC (mA)	VCE (V)	Max (V)	IC (mA)	IB (mA)		
<b>TO-92 (P.31)</b>														
SB764	PNP	-60	-50	-1000	900	60	320	-50	-2	-0.7	-500	-50	150	ECB
SB772S	PNP	-40	-30	-3000	750	100	400	-1000	-2	-0.3	-2000	-200	80	ECB
SC1815	NPN	60	50	150	400	120	700	2	6	0.25	100	10	80	ECB
SC1959	NPN	35	30	500	500	120	240	100	1	0.25	100	10	300	ECB
SC2228Y	NPN	160	160	50	900	60	320	10	10	0.6	20	2	50	ECB
SC2240	NPN	150	150	100	625	120	400	2	6	0.3	10	1	100	ECB
SC3953S	NPN	120	120	200	900	60	320	10	10	1	30	3	400	ECB
SC945	NPN	60	50	100	250	135	600	1	6	0.1	100	10	150	ECB
SD1609S	NPN	160	160	100	900	60	320	10	5	2	30	3	140	ECB
SD1616A	NPN	120	60	1000	750	135	600	100	2	0.3	1000	50	100	ECB
SD468	NPN	25	20	1000	900	85	240	500	2	0.5	800	80	190	ECB
SD471A	NPN	40	30	1000	800	70	400	100	1	0.5	1000	100	130	ECB
SD667A	NPN	120	100	1000	900	60	200	150	5	1	500	50	140	ECB
SD879	NPN	30	10	3000	750	140	400	3000	2	0.3	3000	60	200	ECB
SD882S	NPN	40	30	3000	750	100	500	1000	2	0.5	2000	200	90	ECB
SD965	NPN	40	20	5000	750	230	800	500	2	0.35	3000	100	150	ECB
T666	NPN	75	40	600	625	100	300	150	10	0.3	150	15	300	ECB
TL145	NPN	500	500	300	1000	50	300	20	10	0.5	20	2	10	EBC
TL194	PNP	-400	-400	-300	1000	50	300	-20	-10	-0.2	-20	-2	10	ECB
TL195	PNP	-500	-500	-300	1000	50	300	-20	-10	-0.5	-20	-2	10	ECB
<b>TO-220 (P.30)</b>														
H2584	PNP	-20	-15	-10	65	1K	60K	-10	-1.7	-1.5	-10	-10		BCE
H2585	PNP	-20	-15	-5	40	1K	60K	-5	-1.7	-1.5	-5	-5		BCE
2N6388	NPN	80	80	10	65	1K	20K	5	3	2	5	10		BCE
2N6668	PNP	-80	-80	-10	65	1K	20K	-5	-3	-2	-5	-10		BCE
BU406	NPN	400	200	7	60	30	125	2	5	1	5	500		BCE
BU407	NPN	330	150	7	60	35	200	2	5	1	5	500	10	BCE
D44H11	NPN	80	80	10	50	60	-	2	1	1	8	400	50	BCE
D45H11	PNP	-80	-80	-10	50	60	-	-2	-1	-1	-8	-800	40	BCE
LB124E	NPN	600	400	2	35	10	40	0.3	5	0.3	0.1	10	15	BCE
LB125E	NPN	600	400	5	40	10	-	0.01	5	0.5	1	200		BCE
MJE13005	NPN	700	400	4	75	10	60	1	5	0.5	1	200		BCE
MJE13007	NPN	700	400	8	80	10	40	2	5	1	2	400		BCE
MJE13009	NPN	700	400	12	100	10	30	0.5	5	1	5	1000	4	BCE
MJE2955T	PNP	-70	-60	-10	75	20	100	-4	-4	-1.1	-4	-400	2	BCE
MJE3055T	NPN	70	60	10	75	20	100	4	4	1.1	4	400	2	BCE
SB507	PNP	-60	-60	-3	30	40	320	-1	-2	-1	-2	-200	8	BCE
SB857	PNP	-70	-50	-4	40	60	320	-1	-4	-1	-2	-200	15	BCE
SC4242	NPN	450	400	7	40	10	-	4	5	0.8	4	800		BCE
SD1159	NPN	200	60	4.5	40	30	160	1	5	1	4	400	10	BCE
SD313	NPN	60	60	3	30	40	320	1	2	1	2	200	8	BCE
SD880	NPN	60	60	3	30	60	300	0.5	5	1	3	300	3	BCE
TIP102	NPN	100	100	8	80	1K	20K	3	4	2	3	6		BCE
TIP105	PNP	-60	-60	-8	80	1K	20K	-3	-4	-2	-3	-6		BCE
TIP107	PNP	-100	-100	-8	80	1K	20K	-3	-4	-2	-3	-6		BCE
TIP112	NPN	100	100	4	50	1K	-	1	4	2.5	2	8		BCE
TIP117	PNP	-100	-100	-4	50	1K	-	-1	-4	-2.5	-2	-8		BCE
TIP122	NPN	100	100	5	65	1K	-	0.5	3	2	3	12		BCE
TIP125	PNP	-60	-60	-5	65	1K	-	-0.5	-3	-2	-3	-12		BCE
TIP127	PNP	-100	-100	-5	65	1K	-	-0.5	-3	-2	-3	-12		BCE
TIP29C	NPN	100	100	1	30	15	75	1	4	0.7	1	125	3	BCE
TIP31C	NPN	100	100	3	40	10	50	3	4	1.2	3	375	3	BCE
TIP32C	PNP	-100	-100	-3	40	10	50	-3	-4	-1.2	-3	-375	3	BCE
TIP41C	NPN	100	100	6	65	15	75	3	4	1.5	6	600	3	BCE
TIP42C	PNP	-100	-100	-6	65	15	75	-3	-4	-1.5	-6	-600	3	BCE
TIP47	NPN	350	250	1	40	30	150	0.3	10	1	1	200	10	BCE
TIP49	NPN	450	350	1	40	30	150	0.3	10	1	1	200	10	BCE
TIP50	NPN	500	400	1	40	30	150	0.3	10	1	1	200	10	BCE
SC4234	NPN	1200	800	3	45	8	-	1	5	1	1.5	300	8	BCE
<b>TO-3P (P.30)</b>														
MJE13007R	NPN	700	400	8	130	10	30	0.5	5	1	2	400		BCE
MJE13009R	NPN	700	400	12	130	8	40	5	5	1	5	1000		BCE
KTC5242	NPN	230	230	15	130	55	160	7	5	0.4	8	1000	30	BCE

Part Number	NPN or PNP	Maximum Ratings				Electrical Characteristics (Ta=25°C)							ft MHz	PIN
		BVCEO (V)	BVCEO (V)	IC (mA)	PD Ta=25°C (mW)	hFE				VCE(sat)				
						Min	Max	IC (mA)	VCE (V)	Max (V)	IC (mA)	IB (mA)		
<b>T0-252 (P.30)</b>														
J10387	NPN	80	80	10	20	2K	20K	5	3	2	5	10		BCE
J1109	PNP	-160	-160	-0.1	#1.25	60	320	-0.01	-5	-2	-0.03	-3		BCE
J112	NPN	100	100	4	20	1K	12K	2	3	2.5	2	8		BCE
J117	PNP	-100	-100	-4	20	1K	12K	-2	-3	-2	-2	-8		BCE
J122	NPN	100	100	5	20	1K	12K	4	4	2	4	16		BCE
J127	PNP	-100	-100	-5	20	1K	12K	-4	-4	-2	-4	-16		BCE
J13003	NPN	700	400	1.5	15	8	40	0.5	2	1	1	250		BCE
J1538	PNP	-120	-120	-0.2	#1.3	60	320	-0.01	-10	-1	-0.03	-3		BCE
J1609	NPN	160	160	0.1	#1.25	60	320	0.01	5	2	0.03	3		BCE
J200	NPN	40	25	5	10	45	180	2	1	0.75	2	200		BCE
J210	PNP	-40	-25	-5	12.5	45	180	-2	-1	-0.75	-2	-200		BCE
J2584	PNP	-35	-35	-10	20	2K	60K	-0.5	-1.7	-1.5	-10	-10		BCE
J2955	PNP	-70	-60	-10	20	20	100	-4	-4	-1.1	-4	-400		BCE
J3055	NPN	70	60	10	20	20	100	4	4	1.1	4	400		BCE
J31C	NPN	100	100	3	15	10	50	3	4	1.2	3	375		BCE
J32C	PNP	-100	-100	-3	15	10	50	-3	-4	-1.2	-3	-375		BCE
J340	NPN	300	300	0.5	15	30	240	0.05	10	-	-	-		BCE
J350	PNP	-300	-300	-0.5	15	30	240	-0.05	-10	-	-	-		BCE
J3669	NPN	80	80	2	#1.25	300	-	0.5	2	0.5	1	50		BCE
J3953	NPN	120	120	0.2	#1.3	60	320	0.01	10	1	0.03	3		BCE
J41C	NPN	100	100	6	20	15	75	3	4	1.5	6	600		BCE
J42C	PNP	-100	-100	-6	20	15	75	-3	-4	-1.5	-6	-600		BCE
J44H11	NPN	80	80	8	20	60	-	2	1	1	8	400		BCE
J45H11	PNP	-80	-80	-10	20	60	-	-2	-1	-1	-8	-800		BCE
J47	NPN	350	250	1	20	30	150	0.3	10	1	1	200		BCE
J50	NPN	500	400	1	15	30	150	0.3	10	1	1	200		BCE
J649A	PNP	-180	-160	-1.5	20	60	200	-0.15	-5	1	-0.5	-50		BCE
J6668	PNP	-80	-80	-10	20	1K	20K	-5	-3	-2	-5	-10		BCE
J667A	PNP	-120	-100	-1	20	60	200	-0.15	-5	-1	-0.5	-50		BCE
J669A	NPN	180	160	1.5	#1	60	200	0.15	5	1	0.5	50		BCE
J6718	NPN	100	100	1	20	50	250	0.25	1	0.35	0.35	35		BCE
J772	PNP	-40	-30	-3	20	100	500	-1	-2	-0.5	-2	-200		BCE
J882	NPN	40	30	3	10	160	400	1	2	0.5	2	200		BCE

## RF transistors

Part Number	Voltage VCBO (V)	Current Ic (mA)	Frequency (GHz)	Performances stable power gain (type)	Application	Package
<b>SiGe</b>						
GTRFG761	8	35	60	20dB	W-CDMA, LNA, SiGeHBT	SOT-343 (3K/reel) (P.30)
GTRFG843	8	35	60	20dB	Mobile Comm., VCO, SiGeHBT	SOT-763 (3K/reel) (P.29)
GTRFG2105	13	35	25	22.5dB	2.4GHz Wireless LAN, ITS, LNA, SiGeHBT	SOT-343 (3K/reel) (P.30)
GTRFG2105	13	35	25	22.5dB	2.4GHz Wireless LAN, ITS, LNA, SiGeHBT	SOT-763 (3K/reel) (P.29)
GTRFG0105	13	100	17	17dB	W-CDMA, 2.4GHz Wireless LAN, SiGeHBT	SOT-343 (3K/reel) (P.30)
GTRFG0116	13	100	17	17dB	W-CDMA, 2.4GHz Wireless LAN, SiGeHBT	SOT-763 (3K/reel) (P.29)
<b>Silicon</b>						
GTRFS355	20	100	6.5	9.5dB	High-Freq low-noise amplification	TO-92 (P.31)
GTRFS536	30	250	5.3	7.2dB	High-Freq low-noise amplification	SOT-89 (1K/reel) (P.32)
GTRFS356	20	100	7	11.5dB	Microwave	SOT-23 (3K/reel) (P.28)
GTRFS585	20	35	10	10dB	VHF , UHF band	SOT-23 (3K/reel) (P.28)
GTRFS191	9	100	10	3.5dB	Microwave	SOT-23 (3K/reel) (P.28)
GTRFS226	20	100	4.5	9dB	VHF , UHF band	SOT-323 (3K/reel) (P.28)
GTRFS571	20	60	5	5dB	UHF high-Freq	SOT-323 (3K/reel) (P.28)
GTRFS228	20	35	8	7.5dB	VHF , UHF band	SOT-323 (3K/reel) (P.28)
GTRFS193	9	100	4.5	3.5dB	High-Freq low-noise amplification	SOT-323 (3K/reel) (P.28)
GTRFS004	20	60	5	5dB	UHF high-Freq	SOT-523 (3K/reel) (P.28)
GTRFS006	20	100	4.5	9dB	VHF , UHF band	SOT-523 (3K/reel) (P.28)
GTRFS008	20	35	8	7.5dB	VHF , UHF band	SOT-523 (3K/reel) (P.28)
GTRFS195	9	100	4.5	3.5dB	High-Freq low-noise amplification	SOT-523 (3K/reel) (P.28)
GTRFS431	20	60	4.3	5dB	UHF high-Freq	MiniSOT-523 (3K/reel)
GTRFS432	20	100	4.5	10dB	High-Freq low-noise amplification	MiniSOT-523 (3K/reel)
GTRFS434	20	35	8	7.5dB	VHF , UHF band	MiniSOT-523 (3K/reel)
GTRFS437	9	100	4.5	3.5dB	High-Freq low-noise amplification	MiniSOT-523 (3K/reel)
GTRFS614	20	100	4.5	10dB	High-Freq low-noise amplification	SOT-723 ( 10K/reel) (P.28)
GTRFS801	9	100	4.5	3.5dB	High-Freq low-noise amplification	SOT-723 ( 10K/reel) (P.28)
GTRFS192	9	100	4.5	3.5dB	High-Freq low-noise amplification	SOT-143 (3K/reel) (P.30)
GTRFS975	9	30	12	11dB	High-Freq low-noise amplification	SOT-143 (3K/reel) (P.30)
GTRFS194	9	100	4.5	3.5dB	High-Freq low-noise amplification	SOT-343 (3K/reel) (P.30)



# Digital Transistors

Part Number	NPN or PNP	Maximum Ratings				Electrical Characteristics (Ta=25°C)				INPUT			fT MHz	PIN
		BVCBO	BVCEO	IC	PD	hFE				Current	R1	R2		
		(V)	(V)	(mA)	Ta=25°C (mW)	Min	Max	IC (mA)	VCE (V)	Max (mA)	resistance (Ω)	resistance (Ω)		
<b>SOT-323 (P.28)</b>														
DTA114ES3	PNP	-50	-50	-100	200	30	-	-5	-5	-0.88	10K	10K	250	BCE
DTA114TS3	PNP	-50	-50	-100	200	100	600	-1	-5	-0.88	10K	NONE	250	BCE
DTA114YS3	PNP	-50	-50	-100	200	68	-	-5	-5	-0.88	10K	47K	250	BCE
DTA115ES3	PNP	-50	-50	-100	200	82	-	-5	-5	-0.15	100K	100K	250	BCE
DTA123JS3	PNP	-50	-50	-100	200	80	-	-10	-5	-3.6	2.2K	47K	250	BCE
DTA123TS3	PNP	-50	-50	-100	200	100	600	-1	-5	-3.6	2.2K	NONE	250	BCE
DTA123YS3	PNP	-50	-50	-100	200	33	-	-10	-5	-3.6	2.2K	10K	250	BCE
DTA124ES3	PNP	-50	-50	-100	200	56	-	-5	-5	-0.36	22K	22K	250	BCE
DTA143ES3	PNP	-50	-50	-100	200	20	-	-10	-5	-1.8	4.7K	4.7K	250	BCE
DTA143TS3	PNP	-50	-50	-100	200	100	600	-1	-5	-1.8	4.7K	NONE	250	BCE
DTA143XS3	PNP	-50	-50	-100	200	30	-	-10	-5	-1.8	4.7K	10K	250	BCE
DTA143ZS3	PNP	-50	-50	-100	200	80	-	-10	-5	-1.8	4.7K	47K	250	BCE
DTA144ES3	PNP	-50	-50	-100	200	68	-	-5	-5	-0.18	47K	47K	250	BCE
DTA144TS3	PNP	-50	-50	-100	200	100	600	-1	-5	-0.18	47K	NONE	250	BCE
DTA144WS3	PNP	-50	-50	-100	200	56	-	-5	-5	-0.18	47K	22K	250	BCE
DTB114ES3	PNP	-50	-50	-500	200	56	-	-50	-5	0.88	10K	10K	250	BCE
DTC113ZS3	NPN	50	50	100	200	33	-	5	5	7.2	1K	10K	250	BCE
DTC114ES3	NPN	50	50	100	200	30	-	5	5	0.88	10K	10K	250	BCE
DTC114TS3	NPN	50	50	100	200	100	600	1	5	0.88	10K	NONE	250	BCE
DTC114WS3	NPN	50	50	100	200	24	-	10	5	0.88	10K	4.7K	250	BCE
DTC114YS3	NPN	50	50	100	200	68	-	5	5	0.88	10K	47K	250	BCE
DTC115ES3	NPN	50	50	100	200	82	-	5	5	0.15	100K	100K	250	BCE
DTC115GS3	NPN	50	50	100	200	82	-	5	5	0.15	NONE	100K	250	BCE
DTC123TS3	NPN	50	50	100	200	100	600	1	5	3.8	2.2K	NONE	250	BCE
DTC123YS3	NPN	50	50	100	200	33	-	10	5	3.8	2.2K	10K	250	BCE
DTC124ES3	NPN	50	50	100	200	56	-	5	5	0.36	22K	22K	250	BCE
DTC124XS3	NPN	50	50	100	200	68	-	5	5	0.36	22K	47K	250	BCE
DTC143ES3	NPN	50	50	100	200	20	-	10	5	1.8	4.7K	4.7K	250	BCE
DTC143TS3	NPN	50	50	100	200	100	600	1	5	1.8	4.7K	NONE	250	BCE
DTC143XS3	NPN	50	50	100	200	30	-	10	5	1.8	4.7K	10K	250	BCE
DTC143YS3	NPN	50	50	100	200	33	-	10	5	1.8	4.7K	22K	250	BCE
DTC143ZS3	NPN	50	50	100	200	80	-	10	5	1.8	4.7K	47K	250	BCE
DTC144ES3	NPN	50	50	100	200	68	-	5	5	0.18	47K	47K	250	BCE
DTC144TS3	NPN	50	50	100	200	100	600	1	5	0.18	47K	NONE	250	BCE
DTC144VS3	NPN	50	50	100	200	33	-	5	5	0.18	47K	10K	250	BCE
DTC144WS3	NPN	50	50	100	200	56	-	5	5	0.18	47K	22K	250	BCE
DTD113ZS3	NPN	50	50	500	200	56	-	50	5	7.2	1K	10K	250	BCE
DTD114ES3	NPN	50	50	500	200	56	-	50	5	0.88	10K	10K	250	BCE
DTD143ES3	NPN	50	50	500	200	47	-	50	5	1.8	4.7K	4.7K	250	BCE
<b>SOT-523 (P.28)</b>														
DTA114EUS3	PNP	-50	-50	-100	200	30	-	-5	-5	-0.88	10K	10K	250	BCE
DTA114TUS3	PNP	-50	-50	-100	200	100	600	-1	-5	-0.88	10K	NONE	250	BCE
DTA114YUS3	PNP	-50	-50	-100	200	68	-	-5	-5	-0.88	10K	47K	250	BCE
DTA115EUS3	PNP	-50	-50	-100	200	82	-	-5	-5		100K	100K	250	BCE
DTA123JUS3	PNP	-50	-50	-100	200	80	-	-10	-5	-3.6	2.2K	47K	250	BCE
DTA123TUS3	PNP	-50	-50	-100	200	100	600	-1	-5	-3.6	2.2K	NONE	250	BCE
DTA123YUS3	PNP	-50	-50	-100	200	33	-	-10	-5	-3.6	2.2K	10K	250	BCE
DTA124EUS3	PNP	-50	-50	-100	200	56	-	-5	-5	-0.36	22K	22K	250	BCE
DTA143EUS3	PNP	-50	-50	-100	200	20	-	-10	-5	-1.8	4.7K	4.7K	250	BCE
DTA143TUS3	PNP	-50	-50	-100	200	100	600	-1	-5	-1.8	4.7K	NONE	250	BCE
DTA143XUS3	PNP	-50	-50	-100	200	30	-	-10	-5	-1.8	4.7K	10K	250	BCE
DTA143ZUS3	PNP	-50	-50	-100	200	80	-	-10	-5	-1.8	4.7K	47K	250	BCE
DTA144EUS3	PNP	-50	-50	-100	200	68	-	-5	-5	-0.18	47K	47K	250	BCE
DTA144TUS3	PNP	-50	-50	-100	200	100	600	-1	-5	-0.18	47K	NONE	250	BCE
DTA144WUS3	PNP	-50	-50	-100	200	56	-	-5	-5	-0.18	47K	22K	250	BCE
DTB114EUS3	PNP	-50	-50	-500	200	56	-	-50	-5	0.88	10K	10K	250	BCE
DTC113ZUS3	NPN	50	50	100	200	33	-	5	5	7.2	1K	10K	250	BCE
DTC114EUS3	NPN	50	50	100	200	30	-	5	5	0.88	10K	10K	250	BCE
DTC114TUS3	NPN	50	50	100	200	100	600	1	5	0.88	10K	NONE	250	BCE
DTC114WUS3	NPN	50	50	100	200	24	-	10	5	0.88	10K	4.7K	250	BCE
DTC114YUS3	NPN	50	50	100	200	68	-	5	5	0.88	10K	47K	250	BCE
DTC115EUS3	NPN	50	50	100	200	82	-	5	5	0.15	100K	100K	250	BCE
DTC115GUS3	NPN	50	50	100	200	82	-	5	5	0.15	NONE	100K	250	BCE

Part Number	NPN or PNP	Maximum Ratings				Electrical Characteristics (Ta=25°C)				INPUT			fT MHz	PIN
		BVCEO (V)	BVCEO (V)	IC (mA)	PD Ta=25°C (mW)	hFE				Current Max (mA)	R1 resistance (Ω)	R2 resistance (Ω)		
						Min	Max	IC (mA)	VCE (V)					
<b>SOT-523 (P.28)</b>														
DTC124XUS3	NPN	50	50	100	200	68	-	5	5	0.36	22K	47K	250	BCE
DTC143EUS3	NPN	50	50	100	200	20	-	10	5	1.8	4.7K	4.7K	250	BCE
DTC143TUS3	NPN	50	50	100	200	100	600	1	5	1.8	4.7K	NONE	250	BCE
DTC143XUS3	NPN	50	50	100	200	30	-	10	5	1.8	4.7K	10K	250	BCE
DTC143YUS3	NPN	50	50	100	200	33	-	10	5	1.8	4.7K	22K	250	BCE
DTC143ZUS3	NPN	50	50	100	200	80	-	10	5	1.8	4.7K	47K	250	BCE
DTC144EUS3	NPN	50	50	100	200	68	-	5	5	0.18	47K	47K	250	BCE
DTC144TUS3	NPN	50	50	100	200	100	600	1	5	0.18	47K	NONE	250	BCE
DTC144VUS3	NPN	50	50	100	200	33	-	5	5	0.18	47K	10K	250	BCE
DTC144WUS3	NPN	50	50	100	200	56	-	5	5	0.18	47K	22K	250	BCE
DTD113ZUS3	NPN	50	50	500	200	56	-	50	5	7.2	1K	10K	250	BCE
DTD114EUS3	NPN	50	50	500	200	56	-	50	5	0.88	10K	10K	250	BCE
DTD143EUS3	NPN	50	50	500	200	47	-	50	5	1.8	4.7K	4.7K	250	BCE
<b>SOT-363 (P.29)</b>														
BA114ES6R	P*2	-50	-50	-100	200	30	-	-5	-5	-0.88	10K	10K	250	Daul
BA114TS6R	P*2	-50	-50	-100	200	100	600	-1	-5	-0.88	10K	NONE	250	Daul
BA114YS6R	P*2	-50	-50	-100	200	68	-	-5	-5	-0.88	10K	47K	250	Daul
BA124ES6R	P*2	-50	-50	-100	200	56	-	-5	-5	-0.36	22K	22K	250	Daul
BA143TS6R	P*2	-50	-50	-100	200	100	600	-1	-5	-1.8	4.7K	NONE	250	Daul
BA143ZS6R	P*2	-50	-50	-100	200	80	-	-10	-5	-1.8	4.7K	47K	250	Daul
BA144ES6R	P*2	-50	-50	-100	200	68	-	-5	-5	-0.18	47K	47K	250	Daul
BC114ES6R	N*2	50	50	100	200	30	-	5	5	0.88	10K	10K	250	Daul
BC114TS6R	N*2	50	50	100	200	100	600	1	5	0.88	10K	NONE	250	Daul
BC114YS6R	N*2	50	50	100	200	68	-	5	5	0.88	10K	47K	250	Daul
BC124ES6R	N*2	50	50	100	200	56	-	5	5	0.36	22K	22K	250	Daul
BC124XS6R	N*2	50	50	100	200	68	-	5	5	0.36	22K	47K	250	Daul
BC143ES6R	N*2	50	50	100	200	20	-	10	5	1.8	4.7K	4.7K	250	Daul
BC143TS6R	N*2	50	50	100	200	100	600	1	5	1.8	4.7K	NONE	250	Daul
BC143XS6R	N*2	50	50	100	200	30	-	10	5	1.8	4.7K	10K	250	Daul
BC143ZS6R	N*2	50	50	100	200	80	-	10	5	1.8	4.7K	47K	250	Daul
BC144ES6R	N*2	50	50	100	200	68	-	5	5	0.18	47K	47K	250	Daul
BCA114ES6R	N+P	50	50	100	200	30	-	5	5	0.88	10K	10K	250	N+P
		-50	-50	-100	200	30	-	-5	-5	-0.88	10K	10K	250	
BCA124ES6R	N+P	50	50	100	200	56	-	5	5	0.36	22K	22K	250	N+P
		-50	-50	-100	200	56	-	-5	-5	-0.36	22K	22K	250	
<b>SOT-563 (P.29)</b>														
BA114EUS6R	P*2	-50	-50	-100	150	30	-	-5	-5	-0.88	10K	10K	250	Daul
BA114TUS6R	P*2	-50	-50	-100	150	100	600	-1	-5	-0.88	10K	NONE	250	Daul
BA114YUS6R	P*2	-50	-50	-100	150	68	-	-5	-5	-0.88	10K	47K	250	Daul
BA124EUS6R	P*2	-50	-50	-100	150	56	-	-5	-5	-0.36	22K	22K	250	Daul
BA143TUS6R	P*2	-50	-50	-100	150	100	600	-1	-5	-1.8	4.7K	NONE	250	Daul
BA143ZUS6R	P*2	-50	-50	-100	150	80	-	-10	-5	-1.8	4.7K	47K	250	Daul
BA144EUS6R	P*2	-50	-50	-100	150	68	-	-5	-5	-0.18	47K	47K	250	Daul
BC114EUS6R	N*2	50	50	100	150	30	-	5	5	0.88	10K	10K	250	Daul
BC114TUS6R	N*2	50	50	100	150	100	600	1	5	0.88	10K	NONE	250	Daul
BC114YUS6R	N*2	50	50	100	150	68	-	5	5	0.88	10K	47K	250	Daul
BC124EUS6R	N*2	50	50	100	150	56	-	5	5	0.36	22K	22K	250	Daul
BC124XUS6R	N*2	50	50	100	150	68	-	5	5	0.36	22K	47K	250	Daul
BC143EUS6R	N*2	50	50	100	150	20	-	10	5	1.8	4.7K	4.7K	250	Daul
BC143TUS6R	N*2	50	50	100	150	100	600	1	5	1.8	4.7K	NONE	250	Daul
BC143XUS6R	N*2	50	50	100	150	30	-	10	5	1.8	4.7K	10K	250	Daul
BC143ZUS6R	N*2	50	50	100	150	80	-	10	5	1.8	4.7K	47K	250	Daul
BC144EUS6R	N*2	50	50	100	150	68	-	5	5	0.18	47K	47K	250	Daul
BCA114EUS6R	N+P	50	50	100	150	30	-	5	5	0.88	10K	10K	250	N+P
		-50	-50	-100	150	30	-	-5	-5	-0.88	10K	10K	250	
BCA124EUS6R	N+P	50	50	100	150	56	-	5	5	0.36	22K	22K	250	N+P
		-50	-50	-100	150	56	-	-5	-5	-0.36	22K	22K	250	



# Other Package Outline Dimensions

All Dimensions in mm

MiniMELF / MELF

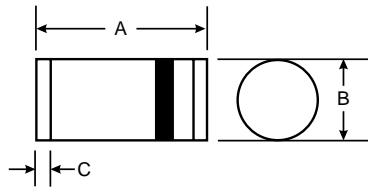

Dim	MiniMELF		MELF	
	Min	Max	Min	Max
A	3.30	3.70	4.80	5.20
B	1.30	1.60	2.40	2.60
C	0.28	0.50	0.55 Nominal	

QuadroMELF / MicroMELF

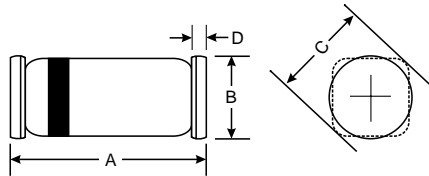

Dim	QuadroMELF		MicroMELF	
	Min	Max	Min	Max
A	3.3	3.7	1.8	2.0
B	1.4	1.6	1.20	1.25
C	1.7 $\varnothing$ Typical		1.35 $\varnothing$ Typical	
D	0.3 Typical		—	

SOD-123 / SOD-323 / SOD-523 / SOD-723

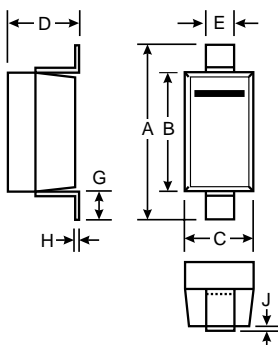

Dim	SOD-123		SOD-323		SOD-523	
	Min	Max	Min	Max	Min	Max
A	3.55	3.85	2.30	2.70	1.50	1.70
B	2.55	2.85	1.60	1.80	1.10	1.30
C	1.40	1.70	1.15	1.35	0.25	0.35
D	—	1.35	0.80	1.10	0.70	0.90
E	0.55 Typical		0.25	0.40	0.10	0.20
G	0.25	—	0.15	0.45	0.50	0.70
H	0.15 Typical		0.10	0.25	All Dimensions in mm	
J	—	0.10	—	0.10		

SOT-23 / SC-59 / SOT-323 / SOT-523

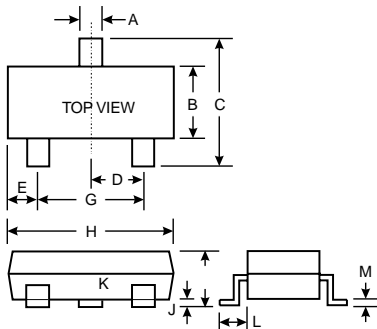

Dim	SOT-23		SC-59		SOT-323 / SOT-523	
	Min	Max	Min	Max	Min	Max
A	0.37	0.51	0.30	0.50	0.30 / 0.15	0.40 / 0.22
B	1.19	1.40	1.40	1.80	1.15 / 0.75	1.35 / 0.85
C	2.10	2.50	2.50	3.00	2.00 / 1.45	2.20 / 1.75
D	0.89	1.05	0.85	1.05	0.65 / 0.5	
E	0.45	0.61	0.30	0.70	0.30 / -	0.40 / -
G	1.78	2.05	1.70	2.10	1.20 / 0.9	1.40 / 1.1
H	2.65	3.05	2.70	3.10	1.80 / 1.5	2.20 / 1.7
J	0.013	0.15	—	0.10	-	0.10
K	0.89	1.10	1.00	1.40	0.90 / 0.6	1.00 / 0.8
L	0.45	0.61	0.55	0.70	0.25 / 0.1	0.40 / 0.3
M	0.076	0.178	0.10	0.35	0.10 / 0.1	0.25 / 0.2

TO-251

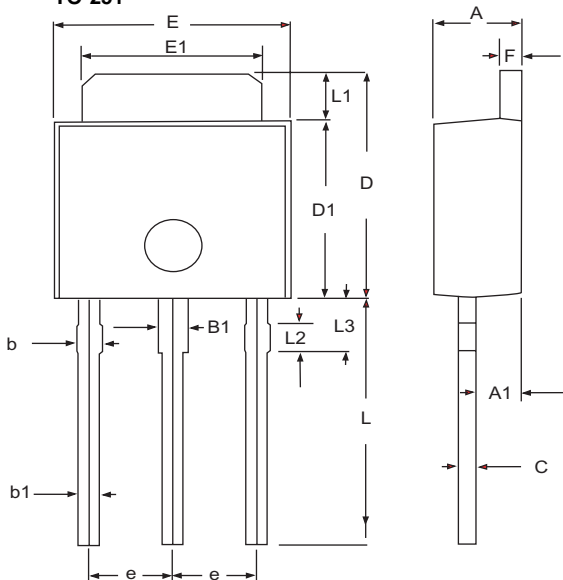

SYMBOLS	MILLIMETERS		INCHES	
	MIN	MAX	MIN	MAX
A	2.20	2.40	0.087	0.095
A1	1.100	1.300	0.043	0.051
B1	0.650	1.050	0.026	0.041
b	0.500	0.900	0.020	0.035
b1	0.400	0.800	0.016	0.32
C	0.400	0.600	0.016	0.024
D	6.700	7.300	0.264	0.287
D1	5.400	5.650	0.213	0.222
E	6.40	6.650	0.252	0.262
e	2.100	2.500	0.083	0.098
F	0.400	0.600	0.016	0.024
L	7.000	8.000	0.276	0.315
L1	1.300	1.700	0.051	0.067
L2	0.700	0.900	0.028	0.035
L3	1.400	1.800	0.055	0.071

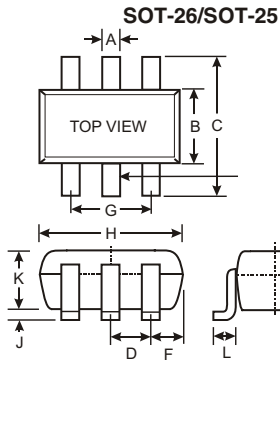

SOT-363/353		
Dim	Min	Max
A	0.10	0.30
B	1.15	1.35
C	2.00	2.20
D	0.65 Nominal	
F	0.30	0.40
H	1.80	2.20
J	—	0.10
K	0.90	1.00
L	0.25	0.40
M	0.10	0.25
$\alpha$	0°	8°

SOT-26/25			
Dim	Min	Max	Typ
A	0.35	0.50	0.38
B	1.50	1.70	1.60
C	2.70	3.00	2.80
D	—	—	0.95
F	—	—	0.55
H	2.90	3.10	3.00
J	0.013	0.10	0.05
K	1.00	1.30	1.10
L	0.35	0.55	0.40
M	0.10	0.20	0.15
$\alpha$	0°	8°	—

SOT-563			
Dim	Min	Max	Typ
A	0.15	0.30	0.25
B	1.10	1.25	1.20
C	1.55	1.70	1.60
D	0.50		
G	0.90	1.10	1.00
H	1.50	1.70	1.60
K	0.56	0.60	0.60
L	0.15	0.25	0.20
M	0.10	0.18	0.11

**All Dimensions in mm**

**SOT-223**

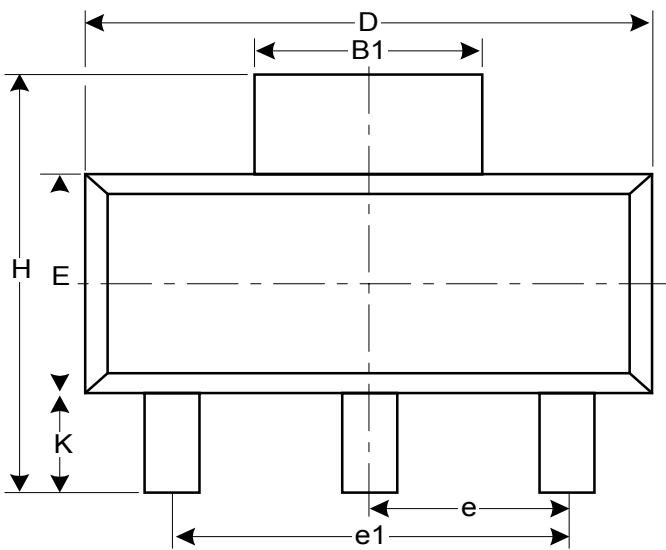

Symbol	Dimensions In Millimeters		
	Min.	Nom.	Max.
A(Thin)	1.50	1.65	1.80
A1	0.02	0.05	0.08
B	0.60	0.70	0.80
B1	2.90	-	3.15(Ref.)
c	0.28	0.30	0.32
D	6.30	6.50	6.70
E	3.30	3.50	3.70
e	2.3 Basic		
e1	4.6 Basic		
H	6.70	7.00	7.30
L	0.91	1.00	1.10
K	1.50	1.75	2.00
$\alpha$	0°	5°	10°
$\beta$	-	13°	-

**SMA, SMB, SMC**

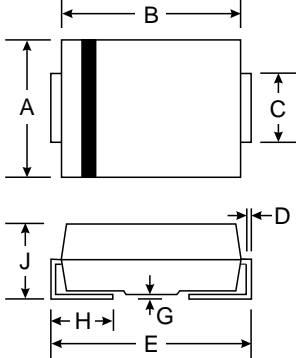

Dim	SMA		SMB		SMC	
	Min	Max	Min	Max	Min	Max
A	2.29	2.92	3.30	3.94	5.59	6.22
B	4.00	4.60	4.06	4.57	6.60	7.11
C	1.27	1.63	1.96	2.21	2.75	3.18
D	0.15	0.31	0.15	0.31	0.15	0.31
E	4.80	5.59	5.00	5.59	7.75	8.13
G	0.10	0.20	0.10	0.20	0.10	0.20
H	0.76	1.52	0.76	1.52	0.76	1.52
J	2.01	2.62	2.00	2.62	2.00	2.62

**DF-S / MBS(MDI)**

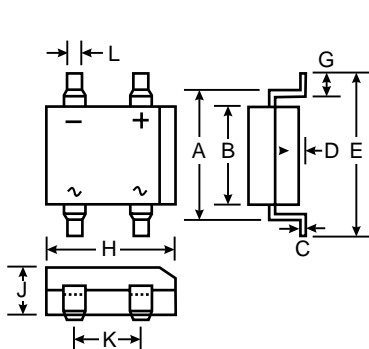

Dim	DF-S		MBS (MDI)		DF-M	
	Min	Max	Min	Max	Min	Max
A	7.40	7.90	5.43	5.75	7.40	7.90
B	6.20	6.50	3.6	4.0	6.20	6.50
C	0.22	0.30	0.15	0.35	0.22	0.30
D	0.076	0.33	0.05	0.20	1.27	2.03
E	—	10.40	—	7.0	7.60	8.90
G	1.02	1.53	0.70	1.10	3.81	4.69
H	8.13	8.51	4.5	4.9	8.13	8.51
J	2.40	3.40	2.8	2.9	2.40	3.40
K	5.00	5.20	2.5	2.7	5.00	5.20
L	1.00	1.20	0.50	0.80	0.46	0.58

**DF-M**

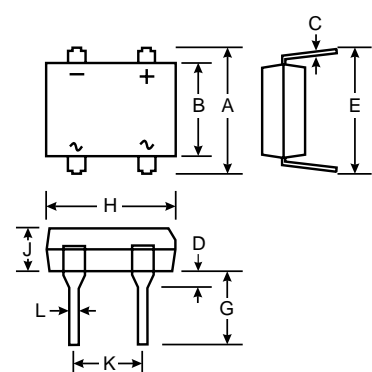

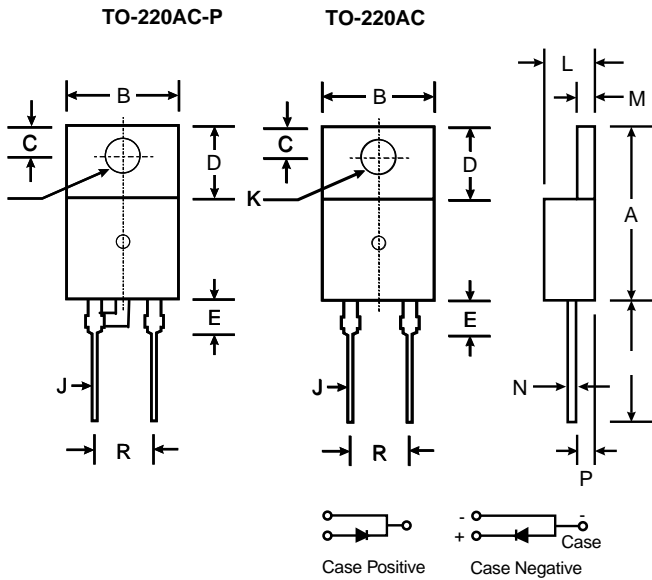

Dim	Min	Max
A	14.22	15.88
B	9.65	10.67
C	2.54	3.43
D	5.84	6.86
E	—	6.35
G	12.70	14.73
H	2.29	2.79
J	0.51	1.14
K	3.53 $\varnothing$	4.09 $\varnothing$
L	3.56	4.83
M	1.14	1.40
N	0.30	0.64
P	2.03	2.92
R	4.83	5.33

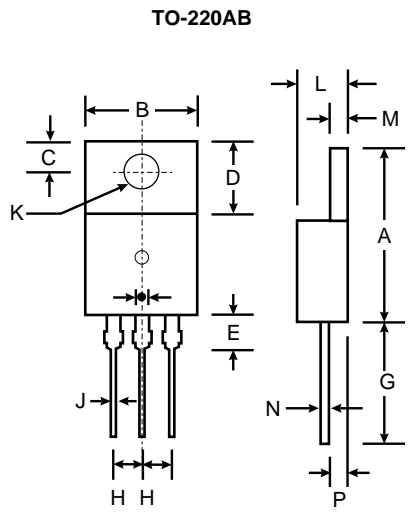

TO-263 / D<sup>2</sup>PAK

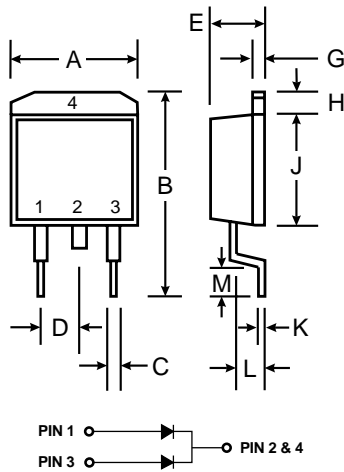

Dim	Min	Max
A	9.65	10.69
B	14.60	15.88
C	0.51	1.14
D	2.29	2.79
E	4.37	4.83
G	1.14	1.40
H	1.14	1.40
J	8.25	9.25
K	0.30	0.64
L	2.03	2.92
M	2.29	2.79

TO-252 / DPAK

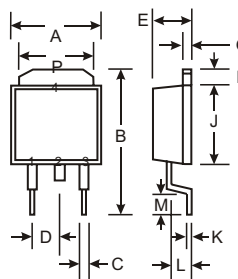

Dim	Min	Max
A	6.3	6.7
B	—	10
C	0.3	0.8
D	2.3 Nominal	
E	2.1	2.5
G	0.4	0.6
H	1.2	1.6
J	5.3	5.7
K	0.5 Nominal	
L	1.3	1.8
M	1.0	—
P	5.1	5.5

TO-3P

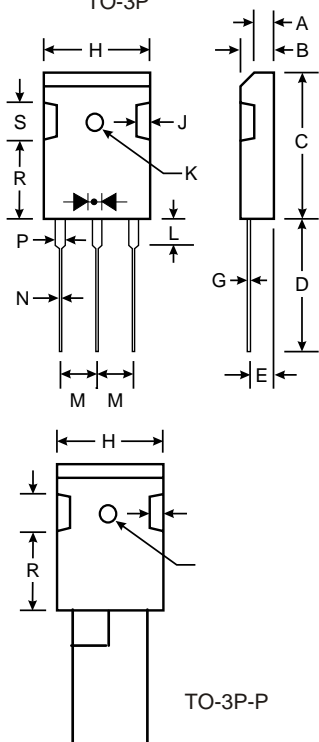

Dim	Min	Max
A	3.20	3.50
B	4.59	5.16
C	20.80	21.30
D	19.70	20.20
E	2.10	2.40
G	0.51	0.76
H	15.90	16.40
J	1.70	2.70
K	3.10 $\varnothing$	3.30 $\varnothing$
L	3.50	4.51
M	5.20	5.70
N	1.12	1.22
P	2.90	3.30
R	11.70	12.80
S	4.30 Typical	

SOT-343 / SOT-143

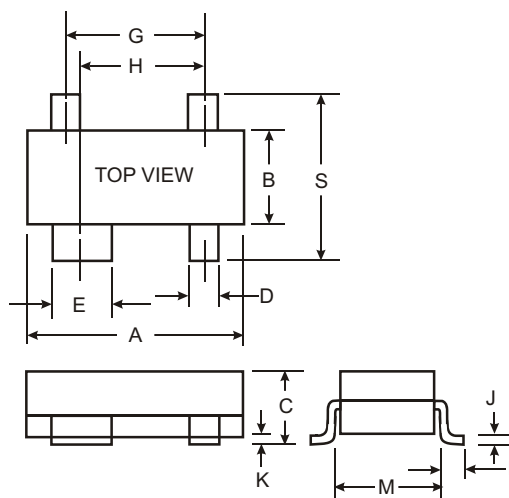

SOT-143		
Dim	Min	Max
A	2.80	3.04
B	1.20	1.40
C	0.80	1.20
D	0.37	0.46
E	0.76	0.89
G	1.92 BSC	
H	1.72 BSC	
J	0.085	0.130
K	0.051	0.127
L	0.25	0.55
M	1.00	1.69
S	2.10	2.64
All Dimensions in mm		

### Axial Devices (Through-Hole)

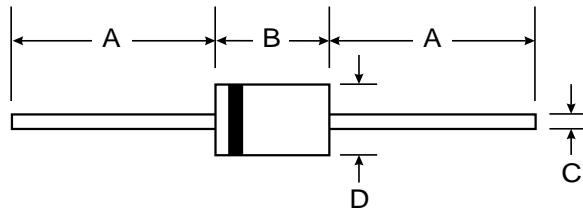

Dim	A		B		C		D	
	Min	Max	Min	Max	Min	Max	Min	Max
A-405	25.40	—	4.10	5.20	0.53	0.64	2.00	2.70
DO-35	25.40	—	—	4.00	—	0.60	—	2.00
DO-41 Plastic	25.40	—	4.06	5.21	0.71	0.864	2.00	2.72
DO-41 Glass	25.40	—	—	4.70	—	0.863	—	2.71
DO-15	25.40	—	5.50	7.62	0.686	0.889	2.60	3.60
DO-201	25.40	—	8.50	9.53	0.96	1.06	4.80	5.21
DO-201AD	25.40	—	7.20	9.50	1.20	1.30	4.80	5.30
R-6	25.40	—	8.60	9.10	1.20	1.30	8.60	9.10
T-1	25.40	—	2.60	3.20	0.53	0.64	2.20	2.60
5W	25.40	—	8.38	8.89	0.94	1.09	3.30	3.68
5KP	25.40	—	—	8.60	0.95	1.07	—	9.53
5KW	25.40	—	—	9.00	1.20	1.30	—	8.00

#### TO-92

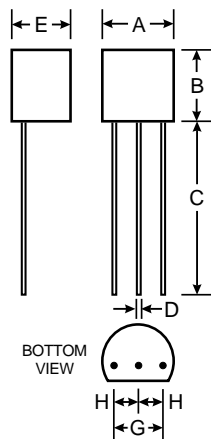

Dim	Min	Max
A	4.32	4.83
B	4.32	4.78
C	12.50	15.62
D	0.36	0.56
E	3.15	3.94
G	2.29	2.79
H	1.14	1.40

#### WOG / AM

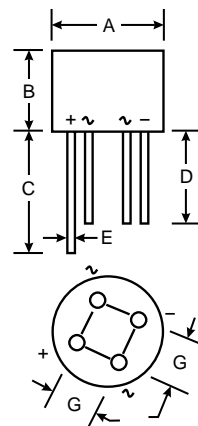

Dim	Min	Max
A	8.84	9.86
B	4.00	4.60
C	27.90	—
D	25.40	—
E	0.71	0.81
G	4.60	5.60

Lead configuration shown is for bulk product packaging only.  
See ANSI/EIA-486 for Radial Tape specifications.

#### SOP-8 / TSSOP-8

Dim	Millimeters SOP-8 / TSSOP-8	
	Min.	Max.
A	1.35 / 1.0	1.75 / 1.2
A1	0.10 / 0.1	0.25 / 0.15
D	4.80 / 2.9	5.00 / 3.1
E	3.80 / 4.3	4.00 / 4.5
H	5.80 / 6.2	6.20 / 6.6
L	0.40 / -	1.27 / -
e1	0.33 / -	0.51 / -
e2	1.27BSC / 0.65BSC	

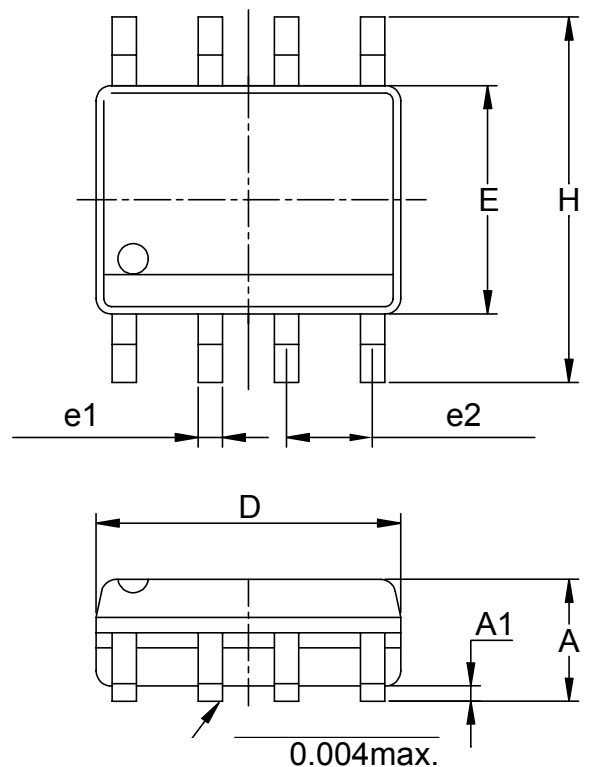

**SOT89**

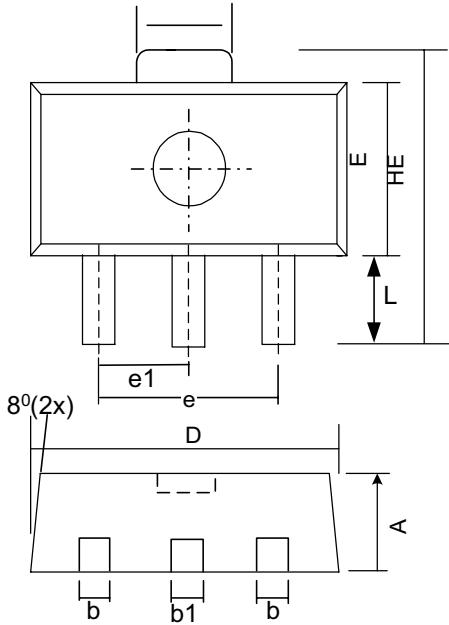

Symbol	Dimensions In Millimeters		
	Min.	Nom.	Max.
A	1.40	1.50	1.60
B	0.36	0.42	0.48
b1	0.41	0.47	0.53
C	0.38	0.40	0.43
D	4.40	4.50	4.60
D1	1.40	1.60	1.75
E	2.90	3.00	3.10
e1	1.45	1.50	1.55
E	2.40	2.50	2.60
HE	3.94	-	4.25
L	0.80	-	1.20

**TO-220-5**

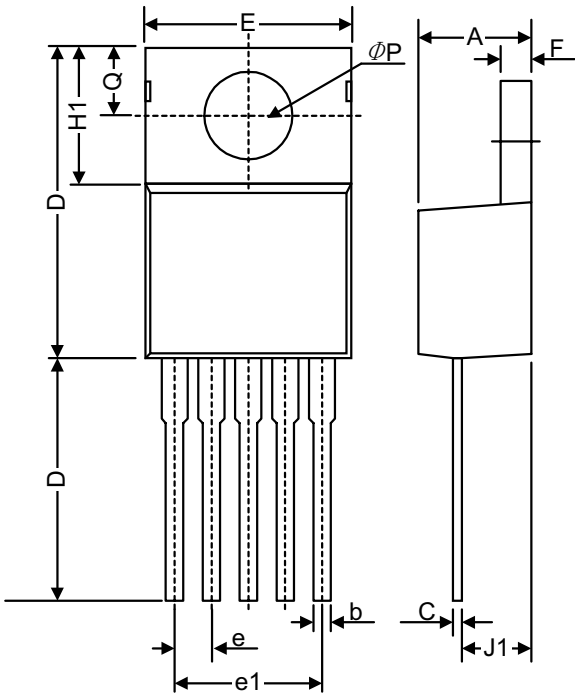

Symbol	Dimensions In Millimeters	
	Min.	Max.
A	4.06	4.8
b	0.76	1.02
C	0.36	0.64
D	14.22	15.49
E	9.78	10.54
e	1.57	1.85
e(1)	6.68	6.93
F	1.14	1.40
H(1)	5.46	6.86
J(1)	2.29	3.18
L	13.21	14.73
$\Phi P$	3.68	3.94
Q	2.54	2.92

**TO-263-5**

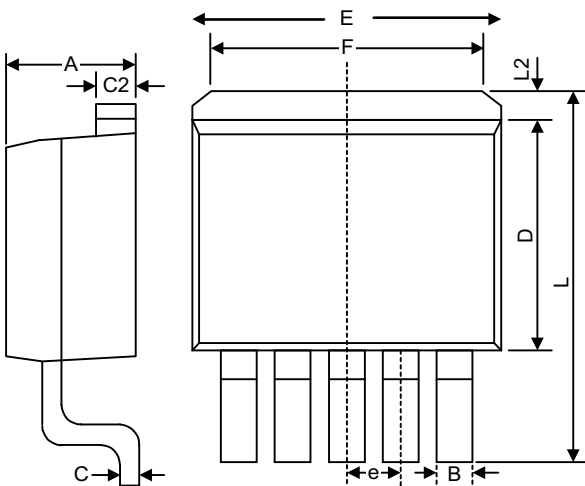

Symbol	Dimensions In Millimeters	
	Min.	Max.
A	4.06	4.83
B	0.76	1.02
C	0.36	0.64
C2	1.14	1.40
D	8.64	9.65
E	9.78	10.54
e	1.57	1.85
F	6.60	7.11
L	15.11	15.37
L2	-	1.40

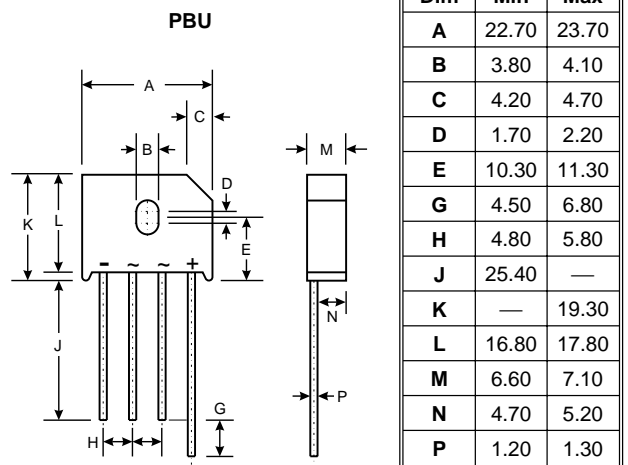
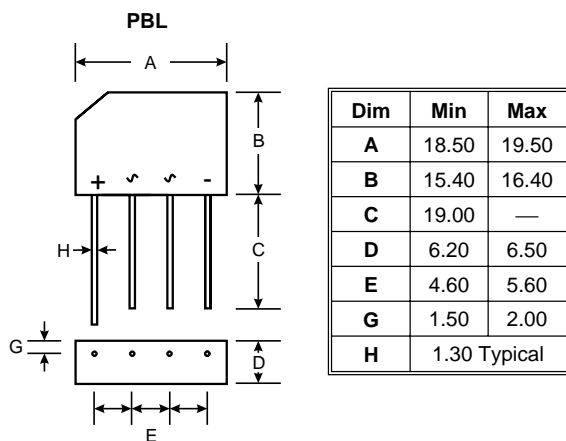
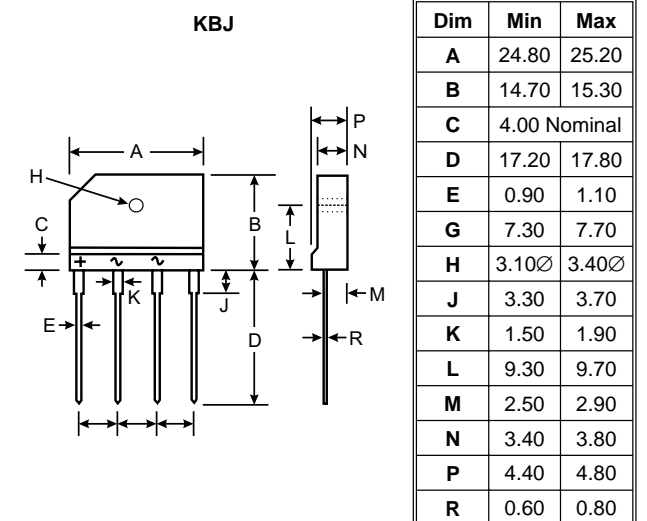
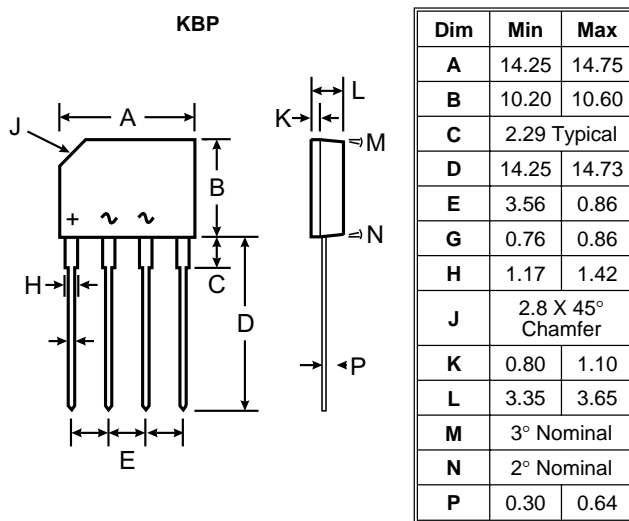
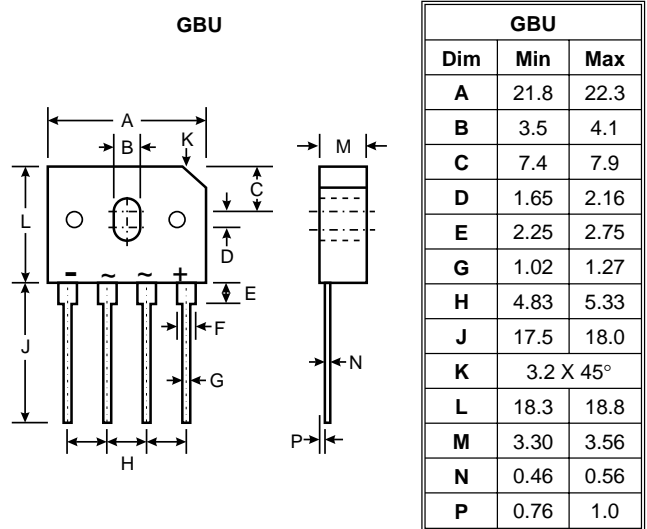
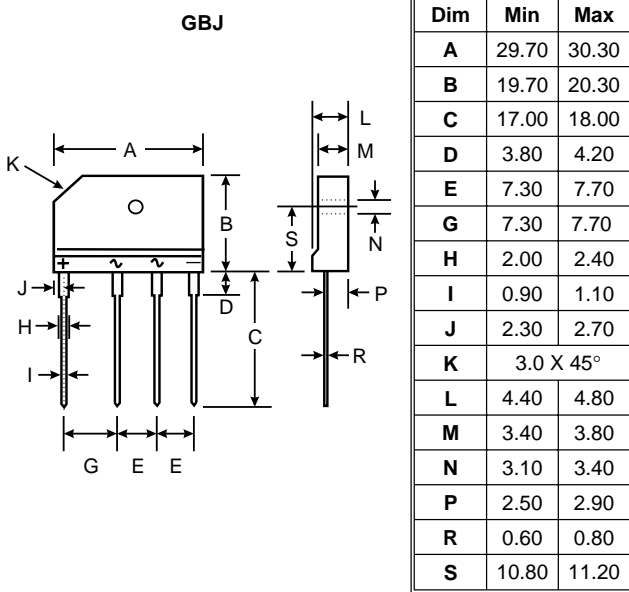



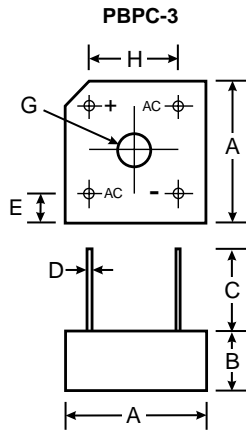

Dim	Min	Max
A	14.73	15.75
B	5.84	6.86
C	19.00	—
D	0.76Ø Typical	
E	1.70	2.70
G	Hole for #6 screw	
	3.60	4.00
H	10.30	11.30

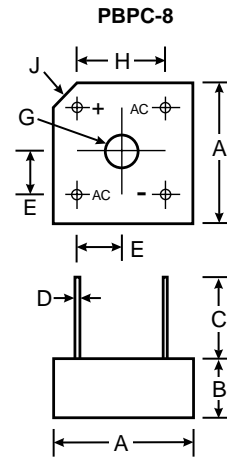

Dim	Min	Max
A	18.54	19.56
B	6.35	7.60
C	22.20	—
D	1.27Ø Typical	
E	5.33	7.37
G	3.60Ø	4.00Ø
H	12.70 Typical	
J	2.38 X 45° Typical	

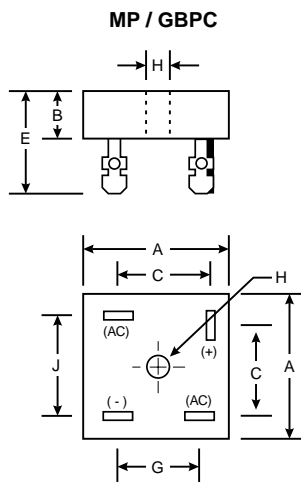

Dim	Min	Max
A	28.30	28.80
B	7.40	8.00
C	16.10	17.10
E	18.80	21.30
G	13.80	14.80
H	Hole for #10 screw	
	4.85Ø	5.59Ø
J	17.60	18.60
K	10.90	11.90
L	0.97Ø	1.07Ø
M	26.4	—
N	7.40	8.00
P	17.60	18.60

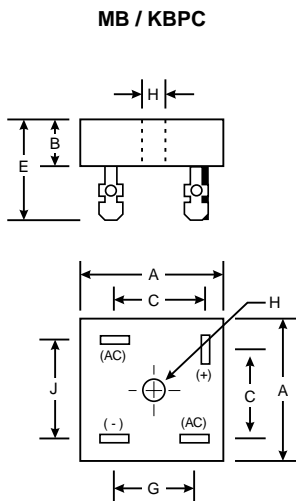
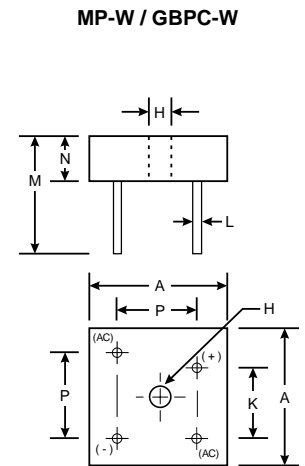

Dim	Min	Max
A	28.40	28.70
B	10.97	11.23
C	15.50	17.60
E	22.86	25.40
G	13.30	15.30
H	Hole for #10 screw	
	4.85Ø	5.59Ø
J	17.10	19.10
K	10.40	12.40
L	0.97Ø Nominal	1.07Ø
M	30.50	—
N	10.97	11.23
P	17.10	19.10

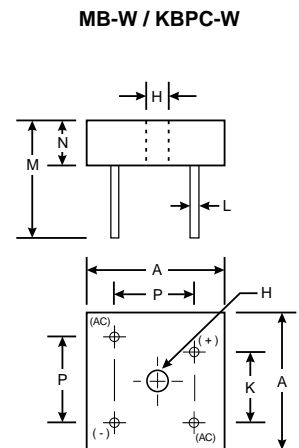

Company :

**SINYORK CO., LTD.**

RM.11 , 3RD Floor No.2 , Fu-Hsing N. RD. ,

Taipei , Taiwan , R.O.C

TEL : +886-2-2740-8097

FAX : +886-2-2752-9638

E-mail : sinyork@ms38.hinet.net

Website : www.sinyork.com.tw

