

# CD54/74AC540, CD54/74AC541 CD54/74ACT540, CD54/74ACT541

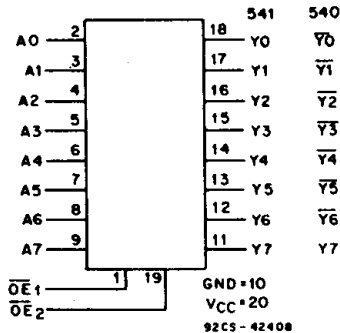

Data sheet acquired from Harris Semiconductor  
SCHS285A – Revised November 1999



FUNCTIONAL DIAGRAM

## Octal Buffer/Line Drivers, 3-State

CD74AC/ACT540 - Inverting  
CD74AC/ACT541 - Non-Inverting

### Type Features:

- Buffered inputs
- Typical propagation delay:  
4.5 ns @  $V_{CC} = 5\text{ V}$ ,  $T_A = 25^\circ\text{C}$ ,  $C_L = 50\text{ pF}$

The CD54/74AC540, -541, and CD54/74ACT540, -541 octal buffer/line drivers use the RCA ADVANCED CMOS technology. The CD54/74AC/ACT540 are inverting 3-state buffers having two active-LOW output enables. The CD54/74AC/ACT541 are non-inverting 3-state buffers having two active-LOW output enables.

The CD74AC540, -541, and CD74ACT540, -541 are supplied in 20-lead dual-in-line plastic packages (E suffix) and in 20-lead dual-in-line small-outline plastic packages (M suffix). Both package types are operable over the following temperature ranges: Industrial (-40 to +85°C) and Extended Industrial/Military (-55 to +125°C).

The CD54AC540, -541, and CD54ACT540, -541, available in chip form (H suffix), are operable over the -55 to +125°C temperature range.

### Family Features:

- Exceeds 2-kV ESD Protection - MIL-STD-883, Method 3015
- SCR-Latchup-resistant CMOS process and circuit design
- Speed of bipolar FAST®/AS/S with significantly reduced power consumption
- Balanced propagation delays
- AC types feature 1.5-V to 5.5-V operation and balanced noise immunity at 30% of the supply.
- ± 24-mA output drive current
  - Fanout to 15 FAST® ICs
  - Drives 50-ohm transmission lines

®FAST is a Registered Trademark of Fairchild Semiconductor Corp.

TRUTH TABLE

CD54/74AC/ACT540		
INPUTS		OUTPUTS
OE1, OE2	A	Y
L	L	H
L	H	L
H	X	Z

TRUTH TABLE

CD54/74AC/ACT541		
INPUTS		OUTPUTS
OE1, OE2	A	Y
L	L	L
L	H	H
H	X	Z

H = High Voltage  
L = Low Voltage  
X = Immaterial  
Z = High Impedance

# CD54/74AC540, CD54/74AC541 CD54/74ACT540, CD54/74ACT541

**MAXIMUM RATINGS, Absolute-Maximum Values:**

DC SUPPLY-VOLTAGE ( $V_{CC}$ )	.....	-0.5 to 6 V
DC INPUT DIODE CURRENT, $I_{IK}$ (for $V_I < -0.5$ or $V_I > V_{CC} + 0.5$ V)	.....	$\pm 20$ mA
DC OUTPUT DIODE CURRENT, $I_{OK}$ (for $V_O < -0.5$ or $V_O > V_{CC} + 0.5$ V)	.....	$\pm 50$ mA
DC OUTPUT SOURCE OR SINK CURRENT per Output Pin, $I_O$ (for $V_O > -0.5$ or $V_O < V_{CC} + 0.5$ V)	.....	$\pm 50$ mA
DC $V_{CC}$ OR GROUND CURRENT ( $I_{CC}$ or $I_{GND}$ )	.....	$\pm 100$ mA*
PACKAGE THERMAL IMPEDANCE, $\theta_{JA}$ (see Note 1): E package	.....	69°C/W
	M package	58°C/W
STORAGE TEMPERATURE ( $T_{stg}$ )	.....	-65 to +150°C
LEAD TEMPERATURE (DURING SOLDERING):		
At distance $1/16 \pm 1/32$ in. ( $1.59 \pm 0.79$ mm) from case for 10 s maximum	.....	+265°C
Unit inserted into PC board min. thickness $1/16$ in. ( $1.59$ mm) with solder contacting lead tips only	.....	+300°C

\* For up to 4 outputs per device: add  $\pm 25$  mA for each additional output.

NOTE 1: The package thermal impedance is calculated in accordance with JESD 51.

**RECOMMENDED OPERATING CONDITIONS:**

For maximum reliability, normal operating conditions should be selected so that operation is always within the following ranges:

CHARACTERISTIC	LIMITS		UNITS
	MIN.	MAX.	
Supply-Voltage Range, $V_{CC}$ *: (For $T_A$ = Full Package-Temperature Range)			
AC Types	1.5	5.5	V
ACT Types	4.5	5.5	V
DC Input or Output Voltage, $V_i, V_o$	0	$V_{CC}$	V
Operating Temperature, $T_A$ :	-55	+125	°C
Input Rise and Fall Slew Rate, $dt/dv$			
at 1.5 V to 3 V (AC Types)	0	50	ns/V
at 3.6 V to 5.5 V (AC Types)	0	20	ns/V
at 4.5 V to 5.5 V (ACT Types)	0	10	ns/V

\*Unless otherwise specified, all voltages are referenced to ground.

**TERMINAL ASSIGNMENT DIAGRAMS**

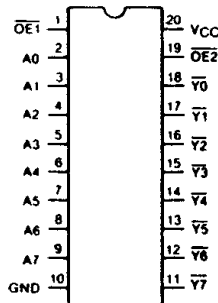

CD54/74AC/ACT540

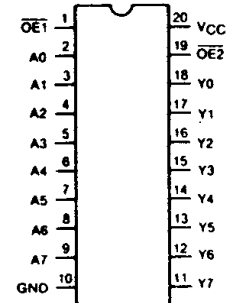

CD54/74AC/ACT541

Technical Data

# CD54/74AC540, CD54/74AC541 CD54/74ACT540, CD54/74ACT541

STATIC ELECTRICAL CHARACTERISTICS: AC Series

CHARACTERISTICS	TEST CONDITIONS		V <sub>CC</sub> (V)	AMBIENT TEMPERATURE (T <sub>A</sub> ) - °C						UNITS	
				+25		-40 to +85		-55 to +125			
				MIN.	MAX.	MIN.	MAX.	MIN.	MAX.		
High-Level Input Voltage V <sub>IH</sub>			1.5	1.2	—	1.2	—	1.2	—	V	
			3	2.1	—	2.1	—	2.1	—		
			5.5	3.85	—	3.85	—	3.85	—		
Low-Level Input Voltage V <sub>IL</sub>			1.5	—	0.3	—	0.3	—	0.3	V	
			3	—	0.9	—	0.9	—	0.9		
			5.5	—	1.65	—	1.65	—	1.65		
High-Level Output Voltage V <sub>OH</sub>	V <sub>IH</sub> or V <sub>IL</sub>	#, *	-0.05	1.5	1.4	—	1.4	—	1.4	—	V
			-0.05	3	2.9	—	2.9	—	2.9	—	
			-0.05	4.5	4.4	—	4.4	—	4.4	—	
			-4	3	2.58	—	2.48	—	2.4	—	
			-24	4.5	3.94	—	3.8	—	3.7	—	
			-75	5.5	—	—	3.85	—	—	—	
			-50	5.5	—	—	—	—	3.85	—	
Low-Level Output Voltage V <sub>OL</sub>	V <sub>IH</sub> or V <sub>IL</sub>	#, *	0.05	1.5	—	0.1	—	0.1	—	0.1	V
			0.05	3	—	0.1	—	0.1	—	0.1	
			0.05	4.5	—	0.1	—	0.1	—	0.1	
			12	3	—	0.36	—	0.44	—	0.5	
			24	4.5	—	0.36	—	0.44	—	0.5	
			75	5.5	—	—	—	1.65	—	—	
			50	5.5	—	—	—	—	—	1.65	
Input Leakage Current I <sub>I</sub>	V <sub>CC</sub> or GND		5.5	—	±0.1	—	±1	—	±1	μA	
3-State Leakage Current I <sub>OZ</sub>	V <sub>IH</sub> or V <sub>IL</sub> V <sub>O</sub> = V <sub>CC</sub> or GND		5.5	—	±0.5	—	±5	—	±10	μA	
Quiescent Supply Current, MSI I <sub>CC</sub>	V <sub>CC</sub> or GND	0	5.5	—	8	—	80	—	160	μA	

#Test one output at a time for a 1-second maximum duration. Measurement is made by forcing current and measuring voltage to minimize power dissipation.

\* Test verifies a minimum 50-ohm transmission-line-drive capability at +85°C, 75 ohms at +125°C.

Technical Data

# CD54/74AC540, CD54/74AC541 CD54/74ACT540, CD54/74ACT541

**STATIC ELECTRICAL CHARACTERISTICS: ACT Series**

CHARACTERISTICS	TEST CONDITIONS		V <sub>CC</sub> (V)	AMBIENT TEMPERATURE (T <sub>A</sub> ) - °C						UNITS	
				+25		-40 to +85		-55 to +125			
	V <sub>I</sub> (V)	I <sub>O</sub> (mA)		MIN.	MAX.	MIN.	MAX.	MIN.	MAX.		
High-Level Input Voltage	V <sub>IH</sub>		4.5 to 5.5	2	—	2	—	2	—	V	
Low-Level Input Voltage	V <sub>IL</sub>		4.5 to 5.5	—	0.8	—	0.8	—	0.8	V	
High-Level Output Voltage	V <sub>OZH</sub>	V <sub>IH</sub> or V <sub>IL</sub> #, *	-0.05	4.5	4.4	—	4.4	—	4.4	—	V
			-24	4.5	3.94	—	3.8	—	3.7	—	
			-75	5.5	—	—	3.85	—	—	—	
			-50	5.5	—	—	—	—	3.85	—	
Low-Level Output Voltage	V <sub>OL</sub>	V <sub>IH</sub> or V <sub>IL</sub> #, *	0.05	4.5	—	0.1	—	0.1	—	0.1	V
			24	4.5	—	0.36	—	0.44	—	0.5	
			75	5.5	—	—	—	1.65	—	—	
			50	5.5	—	—	—	—	—	1.65	
Input Leakage Current	I <sub>I</sub>	V <sub>CC</sub> or GND	5.5	—	±0.1	—	±1	—	±1	μA	
3-State Leakage Current	I <sub>OZ</sub>	V <sub>IH</sub> or V <sub>IL</sub> V <sub>O</sub> = V <sub>CC</sub> or GND	5.5	—	±0.5	—	±5	—	±10	μA	
Quiescent Supply Current, MSI	I <sub>CC</sub>	V <sub>CC</sub> or GND	0	5.5	—	8	—	80	—	160	μA
Additional Quiescent Supply Current per Input Pin TTL Inputs High 1 Unit Load	ΔI <sub>CC</sub>	V <sub>CC</sub> -2.1	4.5 to 5.5	—	2.4	—	2.8	—	3	mA	

#Test one output at a time for a 1-second maximum duration. Measurement is made by forcing current and measuring voltage to minimize power dissipation.

\* Test verifies a minimum 50-ohm transmission-line-drive capability at +85°C, 75 ohms at +125°C.

**ACT INPUT LOADING TABLE**

INPUT	UNIT LOAD*	
	540	541
DATA	1.42	0.5
OE1, OE2	1.3	1.3

\*Unit load is ΔI<sub>CC</sub> limit specified in Static Characteristics Chart, e.g., 2.4 mA max. @ 25°C.

**Technical Data**

**CD54/74AC540, CD54/74AC541  
CD54/74ACT540, CD54/74ACT541**

SWITCHING CHARACTERISTICS: AC Series;  $t_r, t_f = 3 \text{ ns}$ ,  $C_L = 50 \text{ pF}$

CHARACTERISTICS	SYMBOL	$V_{CC}$ (V)	AMBIENT TEMPERATURE ( $T_A$ ) - °C				UNITS
			-40 to +85		-55 to +125		
			MIN.	MAX.	MIN.	MAX.	
Propagation Delays: Data to Output AC540	$t_{PLH}$	1.5	—	77	—	85	ns
	$t_{PHL}$	3.3*	2.4	8.6	2.4	9.5	
AC541		5†	1.8	6.2	1.7	6.8	
Enable, to Output to Output	$t_{PLH}$	1.5	—	89	—	98	ns
	$t_{PHL}$	3.3	2.8	9.9	2.7	10.9	
		5	2.1	7.1	2	7.8	
Disable to Output to Output	$t_{PZL}$	1.5	—	136	—	150	ns
	$t_{PZH}$	3.3	4.6	16.4	4.5	18	
		5	3.1	10.9	3	12	
Power Dissipation Capacitance AC540 AC541	$C_{PD}‡$	—	60 Typ.		60 Typ.		pF
		—	60 Typ.		60 Typ.		
Min. (Valley) $V_{OH}$ During Switching of Other Outputs (Output Under Test Not Switching)	$V_{OHV}$ See Fig. 1	5	4 Typ. @ 25°C				V
Max. (Peak) $V_{OL}$ During Switching of Other Outputs (Output Under Test Not Switching)	$V_{OLP}$ See Fig. 1	5	1 Typ. @ 25°C				V
Input Capacitance	$C_i$	—	—	10	—	10	pF
3-State Output Capacitance	$C_o$	—	—	15	—	15	pF

SWITCHING CHARACTERISTICS: ACT Series;  $t_r, t_f = 3 \text{ ns}$ ,  $C_L = 50 \text{ pF}$

CHARACTERISTICS	SYMBOL	$V_{CC}$ (V)	AMBIENT TEMPERATURE ( $T_A$ ) - °C				UNITS
			-40 to +85		-55 to +125		
			MIN.	MAX.	MIN.	MAX.	
Propagation Delays: Data to Output ACT540	$t_{PLH}$	5†	1.9	6.5	1.8	7.2	ns
	$t_{PHL}$						
ACT541							
Enable to Output	$t_{PLH}$	5†	2.1	7.5	2.1	8.2	ns
	$t_{PHL}$						
Disable to Output	$t_{PZL}$	5	3.5	12.2	3.4	13.4	ns
	$t_{PZH}$						
Power Dissipation Capacitance ACT540 ACT541	$C_{PD}§$	—	60 Typ.		60 Typ.		pF
		—	60 Typ.		60 Typ.		
Min. (Valley) $V_{OH}$ During Switching of Other Outputs (Output Under Test Not Switching)	$V_{OHV}$ See Fig. 1	5	4 Typ. @ 25°C				V
Max. (Peak) $V_{OL}$ During Switching of Other Outputs (Output Under Test Not Switching)	$V_{OLP}$ See Fig. 1	5	1 Typ. @ 25°C				V
Input Capacitance	$C_i$	—	—	10	—	10	pF
3-State Output Capacitance	$C_o$	—	—	15	—	15	pF

\*3.3 V: min. is @ 3.6 V  
max. is @ 3 V

†5 V: min. is @ 5.5 V  
max. is @ 4.5 V

§ $C_{PD}$  is used to determine the dynamic power consumption, per channel.

For AC series,  $P_D = V_{CC}^2 f_i (C_{PD} + C_L)$

For ACT series,  $P_D = V_{CC}^2 f_i (C_{PD} + C_L) + V_{CC} \Delta I_{CC}$  where  $f_i$  = input frequency  
 $C_L$  = output load capacitance  
 $V_{CC}$  = supply voltage.

# CD54/74AC540, CD54/74AC541 CD54/74ACT540, CD54/74ACT541

## PARAMETER MEASUREMENT INFORMATION

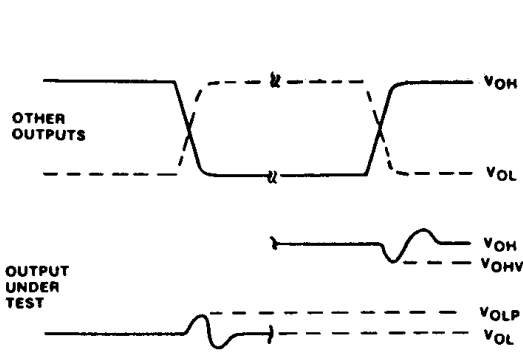

- NOTES:
1.  $V_{OHV}$  AND  $V_{OLP}$  ARE MEASURED WITH RESPECT TO A GROUND REFERENCE NEAR THE OUTPUT UNDER TEST.
  2. INPUT PULSES HAVE THE FOLLOWING CHARACTERISTICS:  
PRR  $\leq$  1 MHz,  $t_r = 3$  ns,  $t_f = 3$  ns, SKEW 1 ns.
  3. R.F. FIXTURE WITH 700-MHz DESIGN RULES REQUIRED. IC SHOULD BE SOLDERED INTO TEST BOARD AND BYPASSED WITH 0.1  $\mu$ F CAPACITOR. SCOPE AND PROBES REQUIRE 700-MHz BANDWIDTH.

92CS-42406

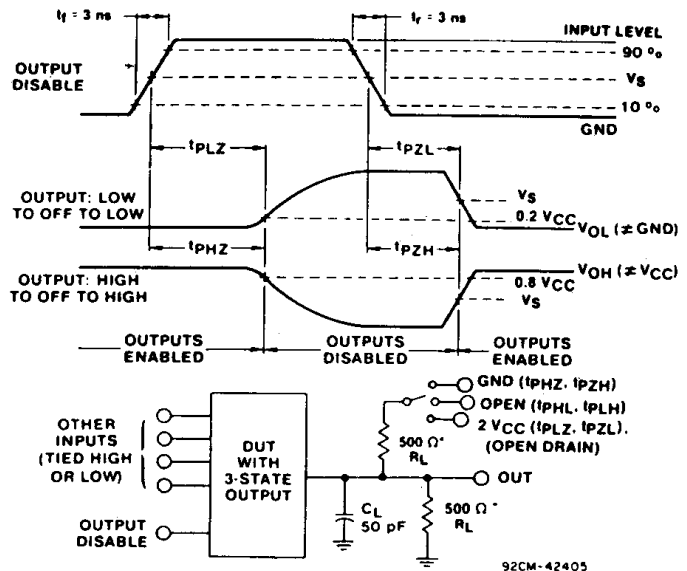

\*FOR AC SERIES ONLY: WHEN  $V_{CC} = 1.5$  V,  $R_L = 1$  k $\Omega$

92CM-42405

Fig. 1 - Simultaneous switching transient waveforms.

Fig. 2 - Three-state propagation delay waveforms and test circuit.

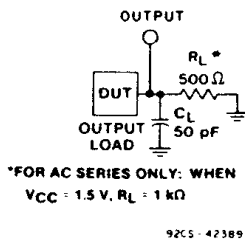

\*FOR AC SERIES ONLY: WHEN  $V_{CC} = 1.5$  V,  $R_L = 1$  k $\Omega$

92CS-42389

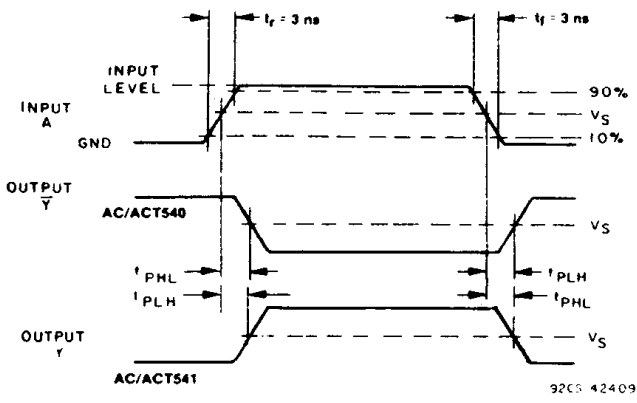

92CS-42409

Fig. 3 - Propagation delay times and test circuit.

	CD54/74AC	CD54/74ACT
Input Level	$V_{CC}$	3 V
Input Switching Voltage, $V_s$	$0.5 V_{CC}$	1.5 V
Output Switching Voltage, $V_s$	$0.5 V_{CC}$	$0.5 V_{CC}$

**PACKAGING INFORMATION**

Orderable Device	Status (1)	Package Type	Package Drawing	Pins	Package Qty	Eco Plan (2)	Lead finish/ Ball material (6)	MSL Peak Temp (3)	Op Temp (°C)	Device Marking (4/5)	Samples
CD54AC541F3A	ACTIVE	CDIP	J	20	1	Non-RoHS & Green	SNPB	N / A for Pkg Type	-55 to 125	CD54AC541F3A	<a href="#">Samples</a>
CD54ACT540F3A	ACTIVE	CDIP	J	20	1	Non-RoHS & Green	SNPB	N / A for Pkg Type	-55 to 125	CD54ACT540F3A	<a href="#">Samples</a>
CD54ACT541F3A	ACTIVE	CDIP	J	20	1	Non-RoHS & Green	SNPB	N / A for Pkg Type	-55 to 125	CD54ACT541F3A	<a href="#">Samples</a>
CD74AC540M	ACTIVE	SOIC	DW	20	25	RoHS & Green	NIPDAU	Level-1-260C-UNLIM	-55 to 125	AC540M	<a href="#">Samples</a>
CD74AC540M96	ACTIVE	SOIC	DW	20	2000	RoHS & Green	NIPDAU	Level-1-260C-UNLIM		AC540M	<a href="#">Samples</a>
CD74AC540ME4	ACTIVE	SOIC	DW	20	25	RoHS & Green	NIPDAU	Level-1-260C-UNLIM	-55 to 125	AC540M	<a href="#">Samples</a>
CD74AC541E	ACTIVE	PDIP	N	20	20	RoHS & Green	NIPDAU	N / A for Pkg Type	-55 to 125	CD74AC541E	<a href="#">Samples</a>
CD74AC541EE4	ACTIVE	PDIP	N	20	20	RoHS & Green	NIPDAU	N / A for Pkg Type	-55 to 125	CD74AC541E	<a href="#">Samples</a>
CD74AC541M	ACTIVE	SOIC	DW	20	25	RoHS & Green	NIPDAU	Level-1-260C-UNLIM	-55 to 125	AC541M	<a href="#">Samples</a>
CD74AC541M96	ACTIVE	SOIC	DW	20	2000	RoHS & Green	NIPDAU	Level-1-260C-UNLIM	-55 to 125	AC541M	<a href="#">Samples</a>
CD74AC541M96E4	ACTIVE	SOIC	DW	20	2000	RoHS & Green	NIPDAU	Level-1-260C-UNLIM	-55 to 125	AC541M	<a href="#">Samples</a>
CD74AC541M96G4	ACTIVE	SOIC	DW	20	2000	RoHS & Green	NIPDAU	Level-1-260C-UNLIM	-55 to 125	AC541M	<a href="#">Samples</a>
CD74AC541SM96	ACTIVE	SSOP	DB	20	2000	RoHS & Green	NIPDAU	Level-1-260C-UNLIM	-55 to 125	AC541SM	<a href="#">Samples</a>
CD74ACT540E	ACTIVE	PDIP	N	20	20	RoHS & Green	NIPDAU	N / A for Pkg Type	-55 to 125	CD74ACT540E	<a href="#">Samples</a>
CD74ACT540M	ACTIVE	SOIC	DW	20	25	RoHS & Green	NIPDAU	Level-1-260C-UNLIM	-55 to 125	ACT540M	<a href="#">Samples</a>
CD74ACT540M96	ACTIVE	SOIC	DW	20	2000	RoHS & Green	NIPDAU	Level-1-260C-UNLIM	-55 to 125	ACT540M	<a href="#">Samples</a>
CD74ACT540M96G4	ACTIVE	SOIC	DW	20	2000	RoHS & Green	NIPDAU	Level-1-260C-UNLIM	-55 to 125	ACT540M	<a href="#">Samples</a>
CD74ACT540MG4	ACTIVE	SOIC	DW	20	25	RoHS & Green	NIPDAU	Level-1-260C-UNLIM	-55 to 125	ACT540M	<a href="#">Samples</a>
CD74ACT541E	ACTIVE	PDIP	N	20	20	RoHS & Green	NIPDAU	N / A for Pkg Type	-55 to 125	CD74ACT541E	<a href="#">Samples</a>

Orderable Device	Status (1)	Package Type	Package Drawing	Pins	Package Qty	Eco Plan (2)	Lead finish/ Ball material (6)	MSL Peak Temp (3)	Op Temp (°C)	Device Marking (4/5)	Samples
CD74ACT541EE4	ACTIVE	PDIP	N	20	20	RoHS & Green	NIPDAU	N / A for Pkg Type	-55 to 125	CD74ACT541E	<a href="#">Samples</a>
CD74ACT541M	ACTIVE	SOIC	DW	20	25	RoHS & Green	NIPDAU	Level-1-260C-UNLIM	-55 to 125	ACT541M	<a href="#">Samples</a>
CD74ACT541M96	ACTIVE	SOIC	DW	20	2000	RoHS & Green	NIPDAU	Level-1-260C-UNLIM	-55 to 125	ACT541M	<a href="#">Samples</a>
CD74ACT541M96E4	ACTIVE	SOIC	DW	20	2000	RoHS & Green	NIPDAU	Level-1-260C-UNLIM	-55 to 125	ACT541M	<a href="#">Samples</a>
CD74ACT541M96G4	ACTIVE	SOIC	DW	20	2000	RoHS & Green	NIPDAU	Level-1-260C-UNLIM	-55 to 125	ACT541M	<a href="#">Samples</a>
CD74ACT541MG4	ACTIVE	SOIC	DW	20	25	RoHS & Green	NIPDAU	Level-1-260C-UNLIM	-55 to 125	ACT541M	<a href="#">Samples</a>
CD74ACT541SM96	ACTIVE	SSOP	DB	20	2000	RoHS & Green	NIPDAU	Level-1-260C-UNLIM	-55 to 125	ACT541SM	<a href="#">Samples</a>
CD74ACT541SM96E4	ACTIVE	SSOP	DB	20	2000	RoHS & Green	NIPDAU	Level-1-260C-UNLIM	-55 to 125	ACT541SM	<a href="#">Samples</a>

(1) The marketing status values are defined as follows:

**ACTIVE:** Product device recommended for new designs.

**LIFEBUY:** TI has announced that the device will be discontinued, and a lifetime-buy period is in effect.

**NRND:** Not recommended for new designs. Device is in production to support existing customers, but TI does not recommend using this part in a new design.

**PREVIEW:** Device has been announced but is not in production. Samples may or may not be available.

**OBSOLETE:** TI has discontinued the production of the device.

(2) **RoHS:** TI defines "RoHS" to mean semiconductor products that are compliant with the current EU RoHS requirements for all 10 RoHS substances, including the requirement that RoHS substance do not exceed 0.1% by weight in homogeneous materials. Where designed to be soldered at high temperatures, "RoHS" products are suitable for use in specified lead-free processes. TI may reference these types of products as "Pb-Free".

**RoHS Exempt:** TI defines "RoHS Exempt" to mean products that contain lead but are compliant with EU RoHS pursuant to a specific EU RoHS exemption.

**Green:** TI defines "Green" to mean the content of Chlorine (Cl) and Bromine (Br) based flame retardants meet JS709B low halogen requirements of <=1000ppm threshold. Antimony trioxide based flame retardants must also meet the <=1000ppm threshold requirement.

(3) MSL, Peak Temp. - The Moisture Sensitivity Level rating according to the JEDEC industry standard classifications, and peak solder temperature.

(4) There may be additional marking, which relates to the logo, the lot trace code information, or the environmental category on the device.

(5) Multiple Device Markings will be inside parentheses. Only one Device Marking contained in parentheses and separated by a "~" will appear on a device. If a line is indented then it is a continuation of the previous line and the two combined represent the entire Device Marking for that device.



(6) Lead finish/Ball material - Orderable Devices may have multiple material finish options. Finish options are separated by a vertical ruled line. Lead finish/Ball material values may wrap to two lines if the finish value exceeds the maximum column width.

**Important Information and Disclaimer:**The information provided on this page represents TI's knowledge and belief as of the date that it is provided. TI bases its knowledge and belief on information provided by third parties, and makes no representation or warranty as to the accuracy of such information. Efforts are underway to better integrate information from third parties. TI has taken and continues to take reasonable steps to provide representative and accurate information but may not have conducted destructive testing or chemical analysis on incoming materials and chemicals. TI and TI suppliers consider certain information to be proprietary, and thus CAS numbers and other limited information may not be available for release.

In no event shall TI's liability arising out of such information exceed the total purchase price of the TI part(s) at issue in this document sold by TI to Customer on an annual basis.

**OTHER QUALIFIED VERSIONS OF CD54AC541, CD54ACT540, CD54ACT541, CD74AC541, CD74ACT540, CD74ACT541 :**

- Catalog : [CD74AC541](#), [CD74ACT540](#), [CD74ACT541](#)
- Military : [CD54AC541](#), [CD54ACT540](#), [CD54ACT541](#)

NOTE: Qualified Version Definitions:

- Catalog - TI's standard catalog product
- Military - QML certified for Military and Defense Applications

**TAPE AND REEL INFORMATION**

**QUADRANT ASSIGNMENTS FOR PIN 1 ORIENTATION IN TAPE**

\*All dimensions are nominal

Device	Package Type	Package Drawing	Pins	SPQ	Reel Diameter (mm)	Reel Width W1 (mm)	A0 (mm)	B0 (mm)	K0 (mm)	P1 (mm)	W (mm)	Pin1 Quadrant
CD74AC540M96	SOIC	DW	20	2000	330.0	24.4	10.8	13.3	2.7	12.0	24.0	Q1
CD74AC541M96	SOIC	DW	20	2000	330.0	24.4	10.8	13.3	2.7	12.0	24.0	Q1
CD74AC541SM96	SSOP	DB	20	2000	330.0	16.4	8.2	7.5	2.5	12.0	16.0	Q1
CD74ACT540M96	SOIC	DW	20	2000	330.0	24.4	10.8	13.3	2.7	12.0	24.0	Q1
CD74ACT541M96	SOIC	DW	20	2000	330.0	24.4	10.8	13.3	2.7	12.0	24.0	Q1
CD74ACT541SM96	SSOP	DB	20	2000	330.0	16.4	8.2	7.5	2.5	12.0	16.0	Q1

**TAPE AND REEL BOX DIMENSIONS**

\*All dimensions are nominal

Device	Package Type	Package Drawing	Pins	SPQ	Length (mm)	Width (mm)	Height (mm)
CD74AC540M96	SOIC	DW	20	2000	367.0	367.0	45.0
CD74AC541M96	SOIC	DW	20	2000	367.0	367.0	45.0
CD74AC541SM96	SSOP	DB	20	2000	853.0	449.0	35.0
CD74ACT540M96	SOIC	DW	20	2000	367.0	367.0	45.0
CD74ACT541M96	SOIC	DW	20	2000	367.0	367.0	45.0
CD74ACT541SM96	SSOP	DB	20	2000	853.0	449.0	35.0

# DB0020A



# PACKAGE OUTLINE

## SSOP - 2 mm max height

SMALL OUTLINE PACKAGE



4214851/B 08/2019

### NOTES:

1. All linear dimensions are in millimeters. Any dimensions in parenthesis are for reference only. Dimensioning and tolerancing per ASME Y14.5M.
2. This drawing is subject to change without notice.
3. This dimension does not include mold flash, protrusions, or gate burrs. Mold flash, protrusions, or gate burrs shall not exceed 0.15 mm per side.
4. This dimension does not include interlead flash. Interlead flash shall not exceed 0.25 mm per side.
5. Reference JEDEC registration MO-150.

# EXAMPLE BOARD LAYOUT

DB0020A

SSOP - 2 mm max height

SMALL OUTLINE PACKAGE



LAND PATTERN EXAMPLE  
EXPOSED METAL SHOWN  
SCALE: 10X



4214851/B 08/2019

NOTES: (continued)

- 6. Publication IPC-7351 may have alternate designs.
- 7. Solder mask tolerances between and around signal pads can vary based on board fabrication site.

# EXAMPLE STENCIL DESIGN

DB0020A

SSOP - 2 mm max height

SMALL OUTLINE PACKAGE



SOLDER PASTE EXAMPLE  
BASED ON 0.125 mm THICK STENCIL  
SCALE: 10X

4214851/B 08/2019

NOTES: (continued)

8. Laser cutting apertures with trapezoidal walls and rounded corners may offer better paste release. IPC-7525 may have alternate design recommendations.
9. Board assembly site may have different recommendations for stencil design.



N (R-PDIP-T\*\*)

PLASTIC DUAL-IN-LINE PACKAGE

16 PINS SHOWN



- NOTES:
- A. All linear dimensions are in inches (millimeters).
  - B. This drawing is subject to change without notice.
  - C Falls within JEDEC MS-001, except 18 and 20 pin minimum body length (Dim A).
  - D The 20 pin end lead shoulder width is a vendor option, either half or full width.

4040049/E 12/2002



# DW0020A



# PACKAGE OUTLINE

## SOIC - 2.65 mm max height

SOIC



4220724/A 05/2016

# EXAMPLE BOARD LAYOUT

DW0020A

SOIC - 2.65 mm max height

SOIC



LAND PATTERN EXAMPLE  
SCALE:6X



SOLDER MASK DETAILS

4220724/A 05/2016

NOTES: (continued)

- 6. Publication IPC-7351 may have alternate designs.
- 7. Solder mask tolerances between and around signal pads can vary based on board fabrication site.

# EXAMPLE STENCIL DESIGN

DW0020A

SOIC - 2.65 mm max height

SOIC



SOLDER PASTE EXAMPLE  
BASED ON 0.125 mm THICK STENCIL  
SCALE:6X

4220724/A 05/2016

NOTES: (continued)

8. Laser cutting apertures with trapezoidal walls and rounded corners may offer better paste release. IPC-7525 may have alternate design recommendations.
9. Board assembly site may have different recommendations for stencil design.

## IMPORTANT NOTICE AND DISCLAIMER

TI PROVIDES TECHNICAL AND RELIABILITY DATA (INCLUDING DATASHEETS), DESIGN RESOURCES (INCLUDING REFERENCE DESIGNS), APPLICATION OR OTHER DESIGN ADVICE, WEB TOOLS, SAFETY INFORMATION, AND OTHER RESOURCES "AS IS" AND WITH ALL FAULTS, AND DISCLAIMS ALL WARRANTIES, EXPRESS AND IMPLIED, INCLUDING WITHOUT LIMITATION ANY IMPLIED WARRANTIES OF MERCHANTABILITY, FITNESS FOR A PARTICULAR PURPOSE OR NON-INFRINGEMENT OF THIRD PARTY INTELLECTUAL PROPERTY RIGHTS.

These resources are intended for skilled developers designing with TI products. You are solely responsible for (1) selecting the appropriate TI products for your application, (2) designing, validating and testing your application, and (3) ensuring your application meets applicable standards, and any other safety, security, or other requirements. These resources are subject to change without notice. TI grants you permission to use these resources only for development of an application that uses the TI products described in the resource. Other reproduction and display of these resources is prohibited. No license is granted to any other TI intellectual property right or to any third party intellectual property right. TI disclaims responsibility for, and you will fully indemnify TI and its representatives against, any claims, damages, costs, losses, and liabilities arising out of your use of these resources.

TI's products are provided subject to TI's Terms of Sale (<https://www.ti.com/legal/termsofsale.html>) or other applicable terms available either on [ti.com](https://www.ti.com) or provided in conjunction with such TI products. TI's provision of these resources does not expand or otherwise alter TI's applicable warranties or warranty disclaimers for TI products.

Mailing Address: Texas Instruments, Post Office Box 655303, Dallas, Texas 75265  
Copyright © 2021, Texas Instruments Incorporated