

# MMBTRA221S...MMBTRA226S

## PNP Silicon Epitaxial Planar Transistor

for high current switching, interface circuit and driver circuit application.

### Feature

- With built-in bias resistor
- Simplify circuit design
- Reduce a quantity of parts and manufacturing process
- High output current

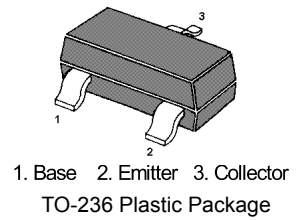
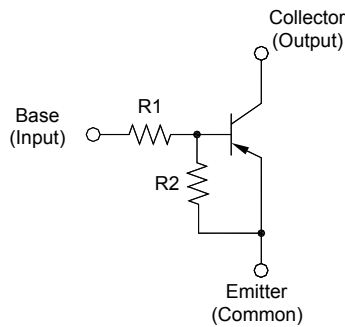

### Resistor Values

Type	R1 (KΩ)	R2 (KΩ)
MMBTRA221S	1	1
MMBTRA222S	2.2	2.2
MMBTRA223S	4.7	4.7
MMBTRA224S	10	10
MMBTRA225S	1	10
MMBTRA226S	2.2	10

### Absolute Maximum Ratings ( $T_a = 25\text{ }^\circ\text{C}$ )

Parameter	Symbol	Value	Unit
Output Voltage	$-V_o$	50	V
Input Voltage	$-V_i$	10, -10	V
		12, -10	
		20, -10	
		30, -10	
		10, -5	
		12, -6	
Output Current	$-I_o$	800	mA
Total Power Dissipation	$P_{tot}$	200	mW
Junction Temperature	$T_j$	150	$^\circ\text{C}$
Storage Temperature Range	$T_{stg}$	- 55 to + 150	$^\circ\text{C}$

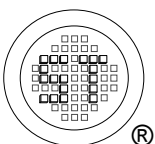

**SEMTECH ELECTRONICS LTD.**



# MMBTRA221S...MMBTRA226S

## Characteristics at $T_a = 25\text{ }^\circ\text{C}$

Parameter	Symbol	Min.	Typ.	Max.	Unit
DC Current Gain at $-V_o = 5\text{ V}$ , $-I_o = 50\text{ mA}$	MMBTRA221S	33	-	-	-
	MMBTRA222S	39	-	-	-
	MMBTRA223S	47	-	-	-
	MMBTRA224S	56	-	-	-
	MMBTRA225S	56	-	-	-
	MMBTRA226S	56	-	-	-
Output Cutoff Current at $-V_o = 30\text{ V}$	$-I_{O(OFF)}$	-	-	10	$\mu\text{A}$
Input Current at $-V_i = 5\text{ V}$	MMBTRA221S	-	-	7.2	mA
	MMBTRA222S	-	-	3.8	
	MMBTRA223S	-	-	1.8	
	MMBTRA224S	-	-	0.88	
	MMBTRA225S	-	-	7.2	
	MMBTRA226S	-	-	3.6	
Output Voltage at $I_o = 50\text{ mA}$ , $I_i = 2.5\text{ mA}$	$-V_{O(ON)}$	-	-	0.3	V
Input Voltage (ON) at $-V_o = 0.3\text{ V}$ , $-I_o = 20\text{ mA}$	MMBTRA221S	-	-	3	V
	MMBTRA222S	-	-	3	
	MMBTRA223S	-	-	3	
	MMBTRA224S	-	-	3	
	MMBTRA225S	-	-	3	
	MMBTRA226S	-	-	2	
Input Voltage (OFF) at $-V_o = 5\text{ V}$ , $-I_o = 0.1\text{ mA}$	MMBTRA221S~224S	$-V_{I(OFF)}$	0.5	-	V
	MMBTRA225S~226S		0.3	-	
Transition Frequency at $-V_o = 10\text{ V}$ , $-I_o = 5\text{ mA}$ , $f = 100\text{ MHz}$	$f_T$ <sup>1)</sup>	-	200	-	MHz

<sup>1)</sup> Characteristic of transistor only.

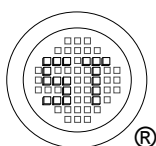

**SEMTECH ELECTRONICS LTD.**



Dated : 16/03/2015 Rev:01

# MMBTRA221S...MMBTRA226S

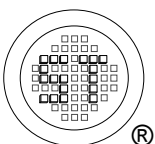
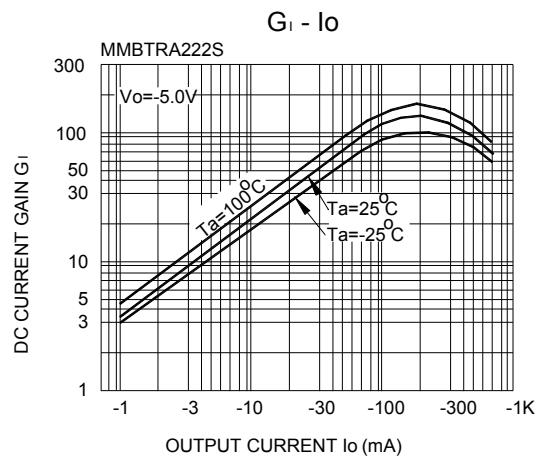
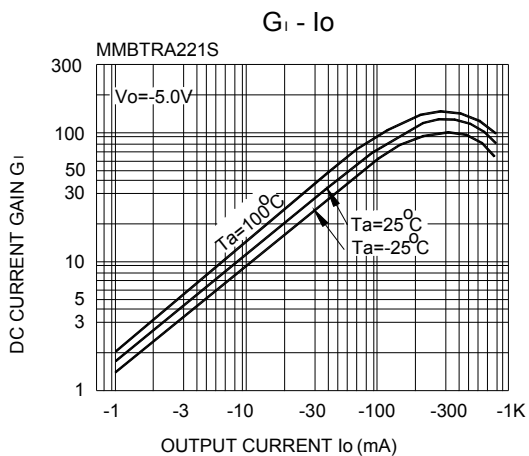
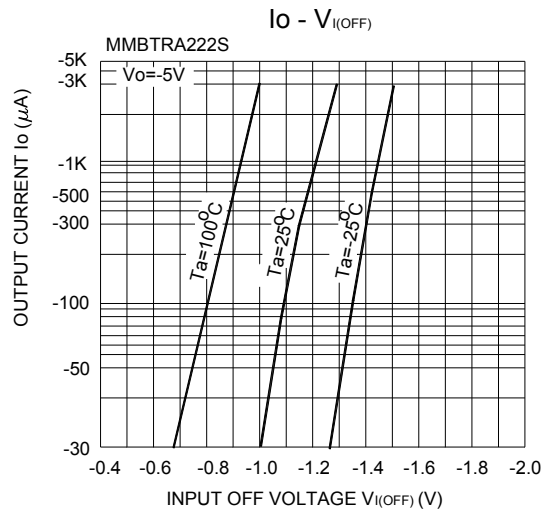
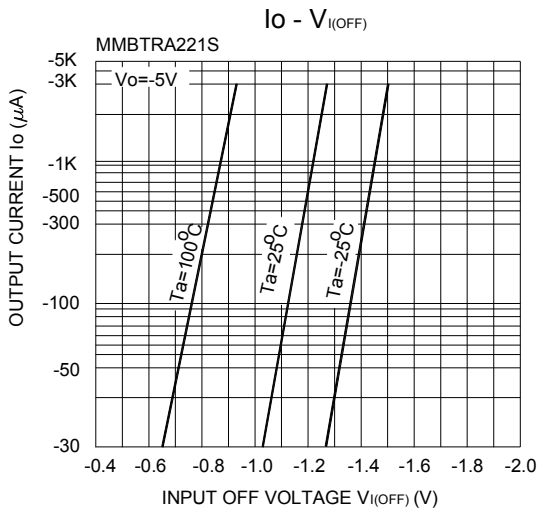
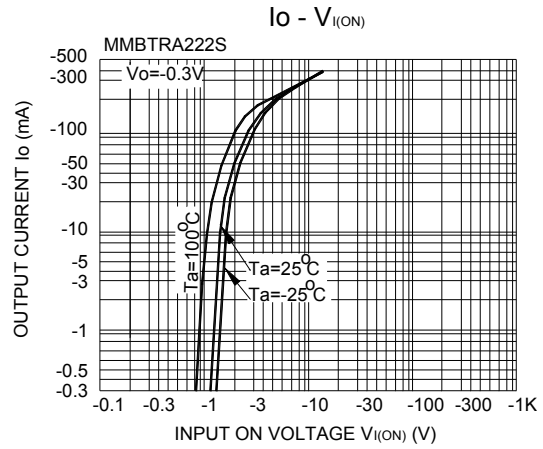
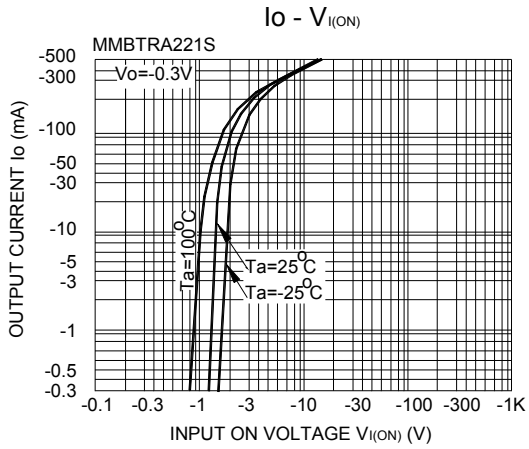

**SEMTECH ELECTRONICS LTD.**



# MMBTRA221S...MMBTRA226S

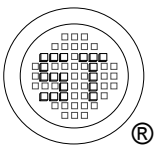
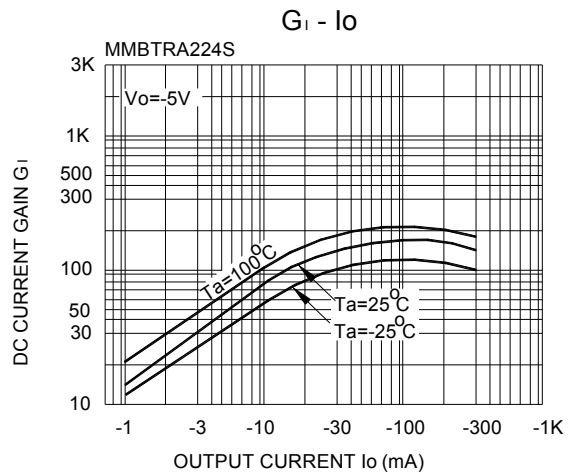
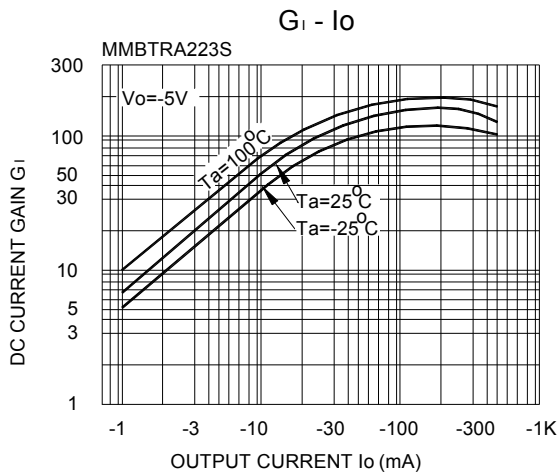
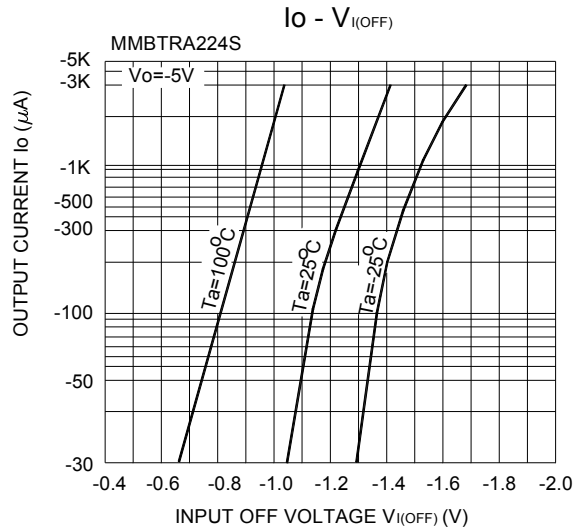
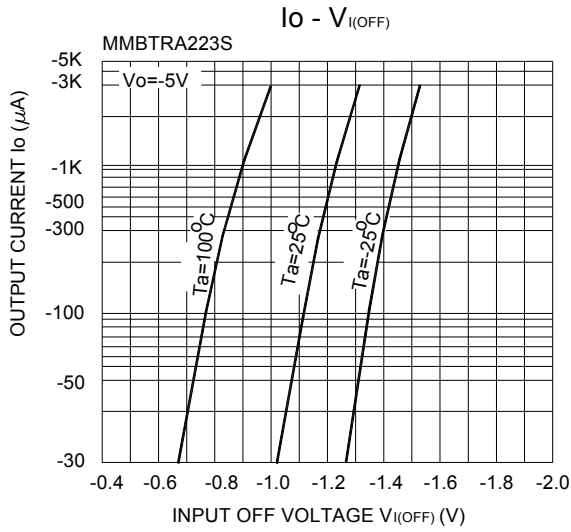
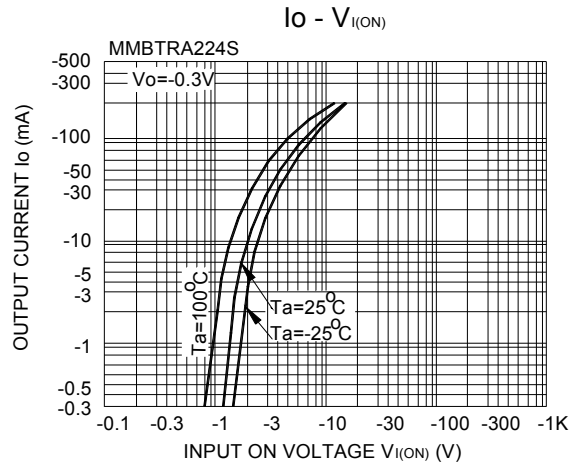
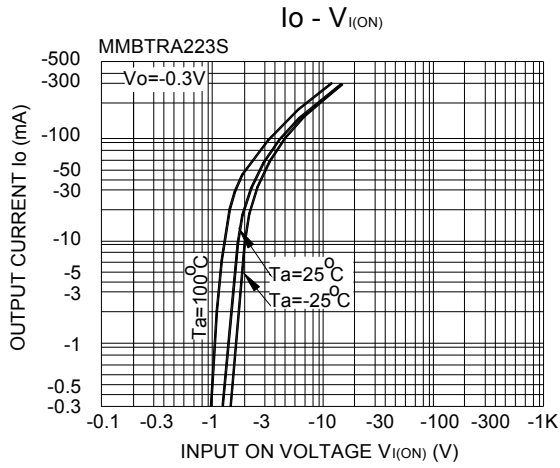

**SEMTECH ELECTRONICS LTD.**



# MMBTRA221S...MMBTRA226S

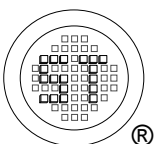
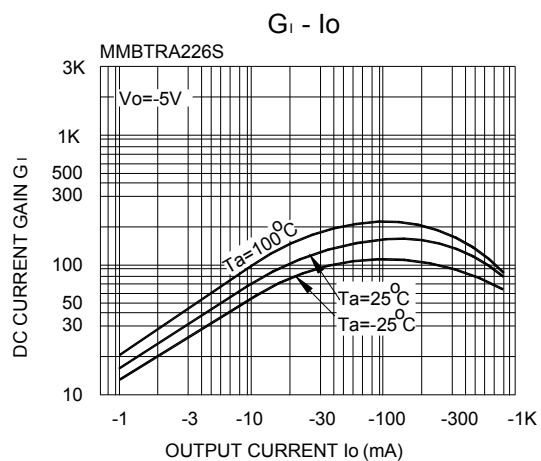
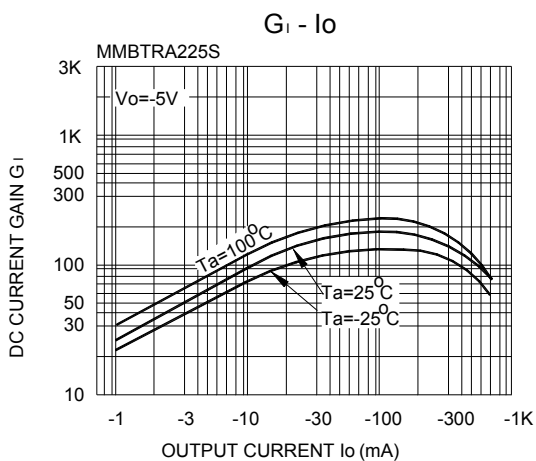
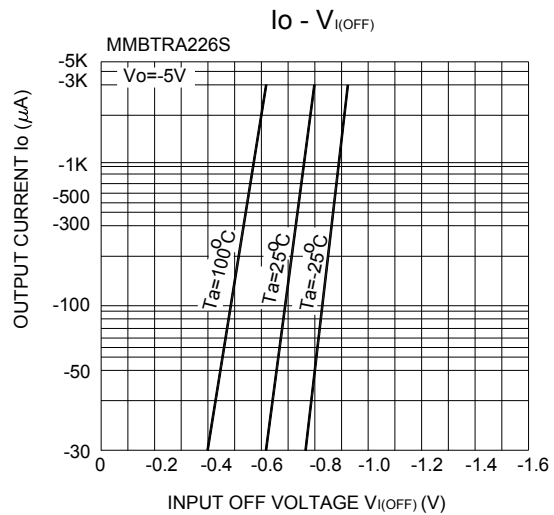
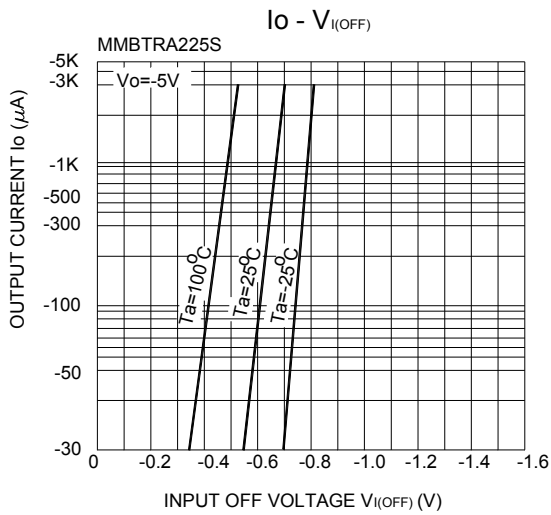
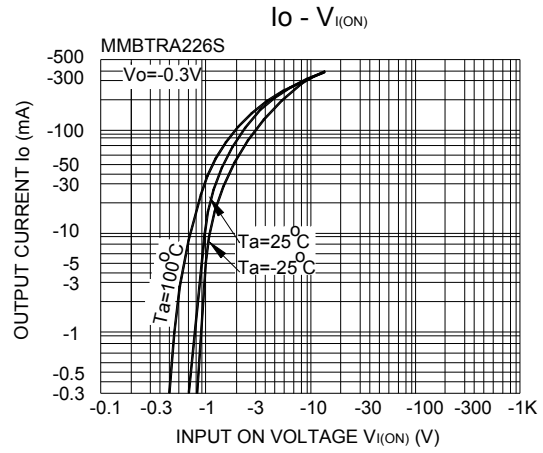
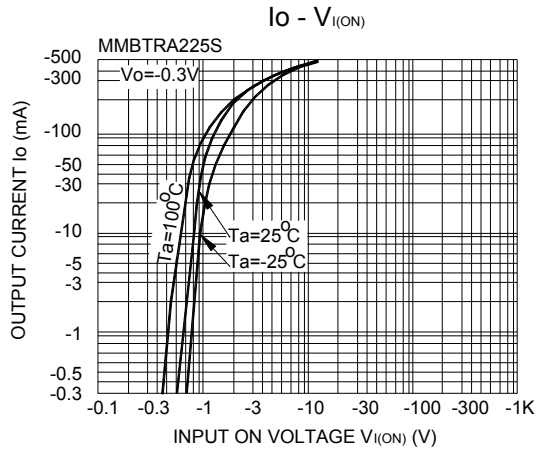

**SEMTECH ELECTRONICS LTD.**

