

2-Line BUS-Port ESD Protection - Flow Through Design

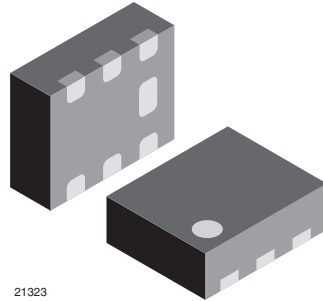

FEATURES

- Compact LLP1713-7L package
- Low package height < 0.6 mm
- 2-line ESD protection
- Low leakage current $I_R < 0.1 \mu A$
- Low load capacitance $C_D = 0.8 pF$
- Ideal for high speed data line like
 - HDMI, DisplayPort, eSATA
 - USB, 1394/firewire
- ESD immunity acc. IEC 61000-4-2
 - $\pm 15 kV$ contact discharge
 - $\pm 15 kV$ air discharge
- Soldering can be checked by standard vision inspection; no X-ray necessary
- e4 - precious metal (e.g. Ag, Au, NiPd, NiPdAu) (no Sn)
- Material categorization: for definitions of compliance please see www.vishay.com/doc?99912

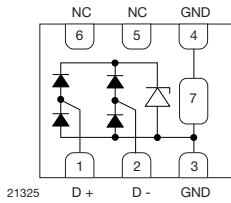

MARKING (example only)



Dot = pin 1 marking
 Y = type code (see table below)
 XX = date code

DESIGN SUPPORT TOOLS click logo to get started



ORDERING INFORMATION			
DEVICE NAME	ORDERING CODE	TAPED UNITS PER REEL (8 mm TAPE ON 7" REEL)	MINIMUM ORDER QUANTITY
VBUS052CD-FAH	VBUS052CD-FAH-GS08	3000	15 000

PACKAGE DATA						
DEVICE NAME	PACKAGE NAME	TYPE CODE	WEIGHT	MOLDING COMPOUND FLAMMABILITY RATING	MOISTURE SENSITIVITY LEVEL	SOLDERING CONDITIONS
VBUS052CD-FAH	LLP1713-7L	G	3.7 mg	UL 94 V-0	MSL level 1 (according J-STD-020)	Peak temperature max. 260 °C

ABSOLUTE MAXIMUM RATINGS VBUS052CD-FAH				
PARAMETER	TEST CONDITIONS	SYMBOL	VALUE	UNIT
Peak pulse current	Acc. IEC 61000-4-5; $t_p = 8/20 \mu s$; single shot	I_{PPM}	3.5	A
Peak pulse power	Acc. IEC 61000-4-5; $t_p = 8/20 \mu s$; single shot	P_{PP}	63	W
ESD immunity	Contact discharge acc. IEC 61000-4-2; 10 pulses	V_{ESD}	± 15	kV
	Air discharge acc. IEC 61000-4-2; 10 pulses	V_{ESD}	± 15	kV
Operating temperature	Junction temperature	T_J	-40 to +125	°C
Storage temperature		T_{STG}	-55 to +150	°C

ELECTRICAL CHARACTERISTICS VBUS052CD-FAH (pin 1 or 2 to pin 3, 4 or 7) ($T_{amb} = 25\text{ }^{\circ}\text{C}$, unless otherwise specified)						
PARAMETER	TEST CONDITIONS/REMARKS	SYMBOL	MIN.	TYP.	MAX.	UNIT
Protection paths	Number of line which can be protected	$N_{channel}$	-	-	2	lines
Reverse stand-off voltage	Max. reverse working voltage	V_{RWM}	-	-	5	V
Reverse voltage	at $I_R = 0.1\text{ }\mu\text{A}$	V_R	5	-	-	V
Reverse current	at $V_{RWM} = 5\text{ V}$	I_R	-	< 0.01	0.1	μA
Reverse breakdown voltage	at $I_R = 1\text{ mA}$	V_{BR}	6.9	7.9	8.7	V
Reverse clamping voltage	at $I_{PP} = 1\text{ A}$	V_C	-	10	12	V
	at $I_{PP} = I_{PPM} = 3.5\text{ A}$	V_C	-	15	18	V
Forward clamping voltage	at $I_F = 1\text{ A}$	V_F	-	1.9	2.4	V
	at $I_{PP} = I_{PPM} = 3.5\text{ A}$	V_F	-	4	5	V
Capacitance	at $V_R = 0\text{ V}$; $f = 1\text{ MHz}$	C_D	-	0.8	1	pF

APPLICATION NOTE

The VBUS052CD-FAH is a two-line ESD protection device with the characteristic of a Z-diode with a high ESD immunity and a very low capacitance which makes it usable for high frequency applications like USB2.0 or HDMI.

With the VBUS052CD-FAH two high speed data lines can be protected against transient voltage signals like ESD (electro static discharge). Connected to the data line (pin 1 and pin 2) and to ground (pin 3) negative transients will be clamped close below the ground level while positive transients will be clamped close above the 5 V working range. The clamping behavior of the VBUS052CD-FAH is bidirectional but asymmetrical (BiAs) and so it offers the best protection for applications running up to 5 V.

Pin configuration:

- Pin 3, 4 and 7 are internally shorted and have to be connected to ground
- Pin 1 and 2 are the inputs for the data lines D_+ and D_- .
- Pin 5 and 6 are not connected internally

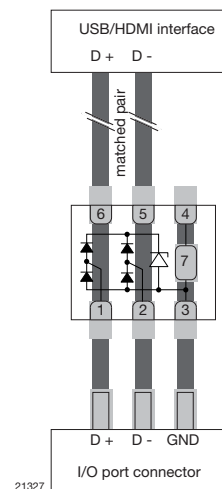
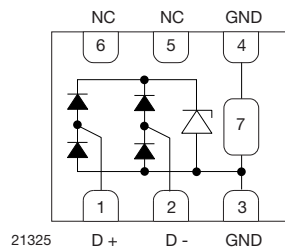

FLOW THROUGH DESIGN

Modern digital transmission lines can be clocked up to 480 Mbit/s (USB2.0) or 1.65 Gbit/s (HDMI).

At such high data rates the transmission lines like cables or the line traces on the PCBs have to be very homogeneous regarding their surge impedance. This requires well defined trace dimensions as trace width and distance which have to be calculated depending on the requested surge impedance (e.g. $50\text{ }\Omega$) and the PCB material and layer dimensions. Any device connected to the data lines - like ESD protection devices - have to be connected with minimal changes in these trace dimensions and distances.

With the package in the so called "Flow Through Design" this is possible. The lines are running straight along the PCB while the VBUS052CD-FAH is placed on top without any vias or loops.

TYPICAL CHARACTERISTICS ($T_{amb} = 25\text{ }^{\circ}\text{C}$, unless otherwise specified)

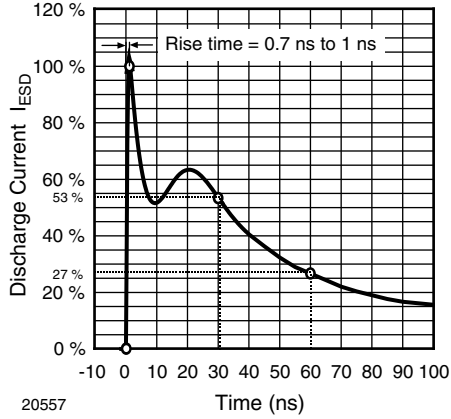

Fig. 1 - ESD Discharge Current Wave Form acc. IEC 61000-4-2 (330 Ω /150 pF)

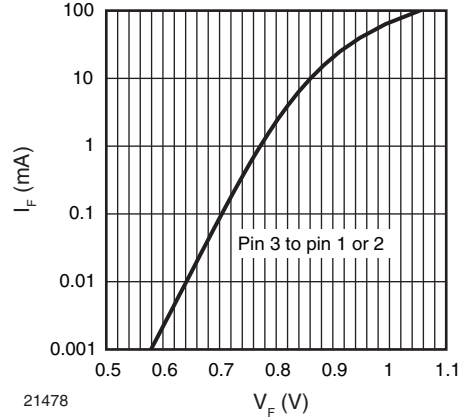

Fig. 4 - Typical Forward Current I_F vs. Forward Voltage V_F

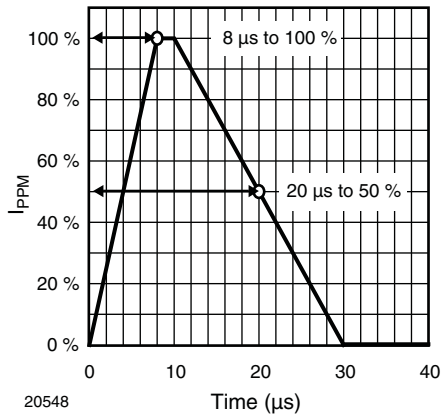

Fig. 2 - 8/20 μs Peak Pulse Current Wave Form acc. IEC 61000-4-5

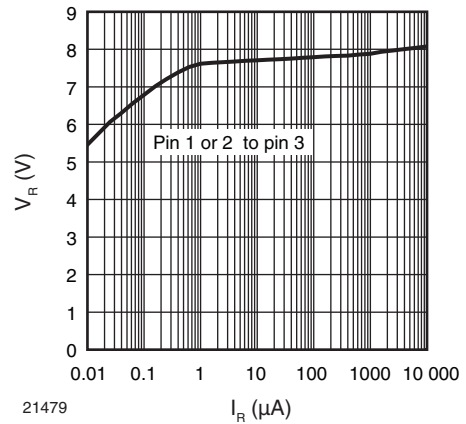

Fig. 5 - Typical Reverse Voltage V_R vs. Reverse Current I_R

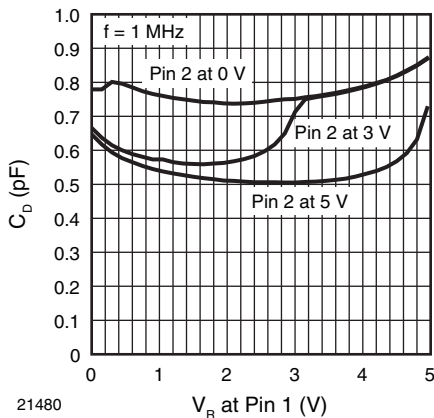

Fig. 3 - Typical Capacitance C_D vs. Reverse Voltage V_R

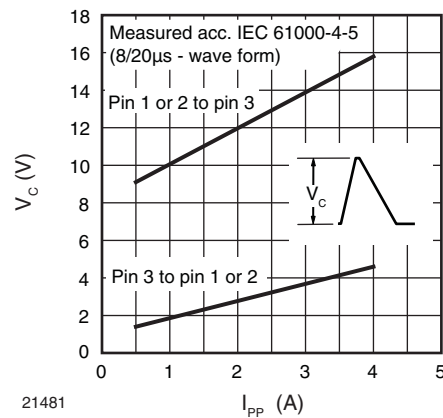

Fig. 6 - Typical Peak Clamping Voltage V_C vs. Peak Pulse Current I_{PP}

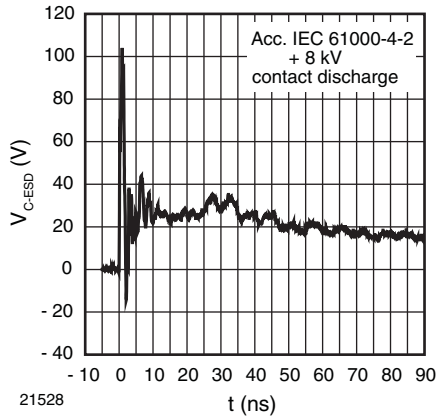

Fig. 7 - Typical Clamping Performance at + 8 kV Contact Discharge (acc. IEC 61000-4-2)

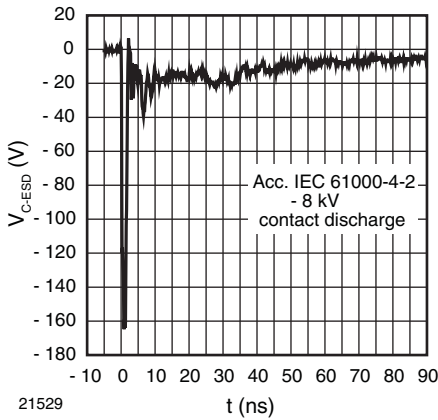

Fig. 8 - Typical Clamping Performance at - 8 kV Contact Discharge (acc. IEC 61000-4-2)

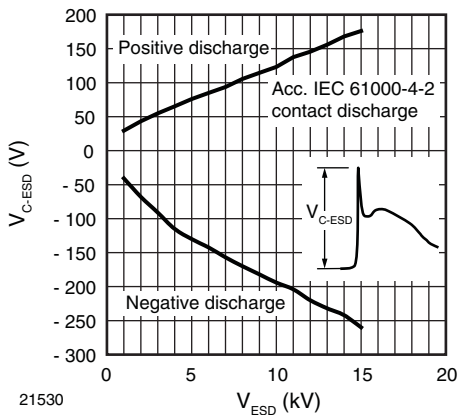
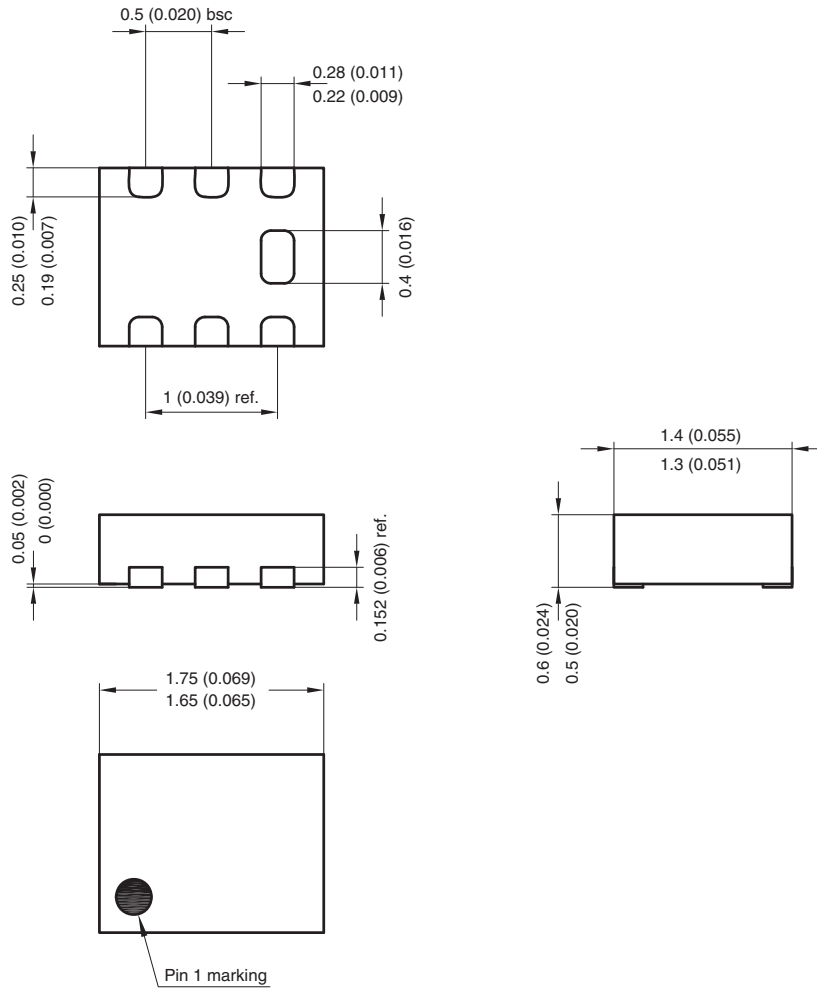

Fig. 9 - Typical Peak Clamping Voltage at ESD Contact Discharge (acc. IEC 61000-4-2)



PACKAGE DIMENSIONS in millimeters (inches): **LLP1713-7L**



Foot print recommendation:

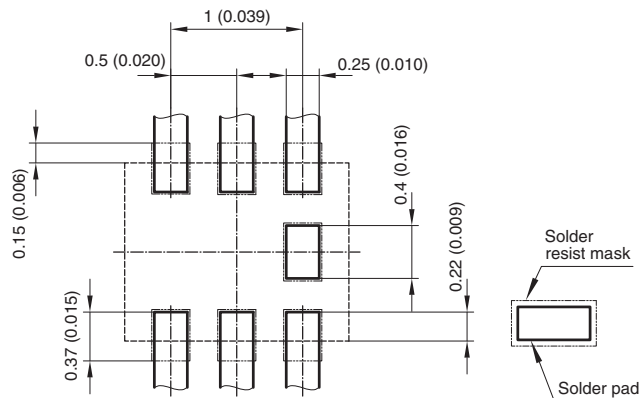

Document no.:S8-V-3906.04-008 (4)
Created - Date: 15. April 2008
Rev. 2 - Date: 09. Sep. 2008
21329

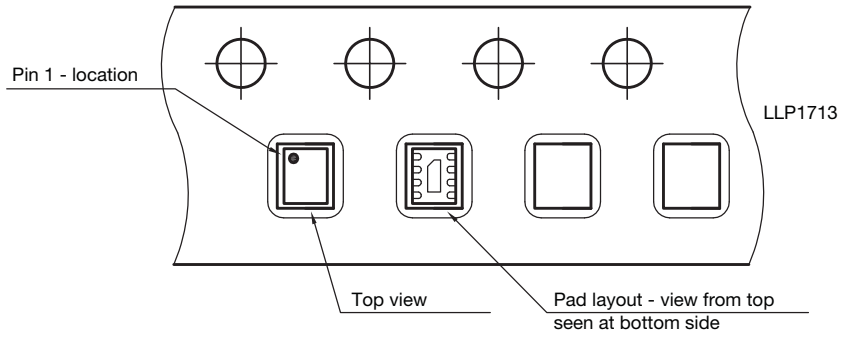



Disclaimer

ALL PRODUCT, PRODUCT SPECIFICATIONS AND DATA ARE SUBJECT TO CHANGE WITHOUT NOTICE TO IMPROVE RELIABILITY, FUNCTION OR DESIGN OR OTHERWISE.

Vishay Intertechnology, Inc., its affiliates, agents, and employees, and all persons acting on its or their behalf (collectively, "Vishay"), disclaim any and all liability for any errors, inaccuracies or incompleteness contained in any datasheet or in any other disclosure relating to any product.

Vishay makes no warranty, representation or guarantee regarding the suitability of the products for any particular purpose or the continuing production of any product. To the maximum extent permitted by applicable law, Vishay disclaims (i) any and all liability arising out of the application or use of any product, (ii) any and all liability, including without limitation special, consequential or incidental damages, and (iii) any and all implied warranties, including warranties of fitness for particular purpose, non-infringement and merchantability.

Statements regarding the suitability of products for certain types of applications are based on Vishay's knowledge of typical requirements that are often placed on Vishay products in generic applications. Such statements are not binding statements about the suitability of products for a particular application. It is the customer's responsibility to validate that a particular product with the properties described in the product specification is suitable for use in a particular application. Parameters provided in datasheets and / or specifications may vary in different applications and performance may vary over time. All operating parameters, including typical parameters, must be validated for each customer application by the customer's technical experts. Product specifications do not expand or otherwise modify Vishay's terms and conditions of purchase, including but not limited to the warranty expressed therein.

Except as expressly indicated in writing, Vishay products are not designed for use in medical, life-saving, or life-sustaining applications or for any other application in which the failure of the Vishay product could result in personal injury or death. Customers using or selling Vishay products not expressly indicated for use in such applications do so at their own risk. Please contact authorized Vishay personnel to obtain written terms and conditions regarding products designed for such applications.

No license, express or implied, by estoppel or otherwise, to any intellectual property rights is granted by this document or by any conduct of Vishay. Product names and markings noted herein may be trademarks of their respective owners.