



High-Speed Multi-Frequency PLL Clock Buffer

Features

- 12–100 MHz (CY7B9930V), or 24–200 MHz (CY7B9940V) input/output operation
- Matched pair output skew < 200 ps
- Zero input-to-output delay
- 10 LVTTTL 50% duty-cycle outputs capable of driving 50Ω terminated lines
- Commercial temp. range with eight outputs at 200 MHz
- Industrial temp. range with eight outputs at 200 MHz
- 3.3V LVTTTL/LV differential (LVPECL), fault-tolerant and hot insertable reference inputs
- Multiply ratios of (1–6, 8, 10, 12)
- Operation up to 12x input frequency
- Individual output bank disable for aggressive power management and EMI reduction
- Output high-impedance option for testing purposes
- Fully integrated PLL with lock indicator
- Low cycle-to-cycle jitter (<100 ps peak-peak)
- Single 3.3V ± 10% supply
- 44-pin TQFP package

Functional Description

The CY7B9930V and CY7B9940V High-Speed Multi-Frequency PLL Clock Buffers offer user-selectable control over system clock functions. This multiple-output clock driver provides the system integrator with functions necessary to optimize the timing of high-performance computer or communication systems.

Ten configurable outputs can each drive terminated transmission lines with impedances as low as 50Ω while delivering minimal and specified output skews at LVTTTL levels. The outputs are arranged in three banks. The FB feedback bank consists of two outputs, which allows divide-by functionality from 1 to 12. Any one of these ten outputs can be connected to the feedback input as well as driving other inputs.

Selectable reference input is a fault tolerance feature that allows smooth change over to secondary clock source, when the primary clock source is not in operation. The reference inputs are configurable to accommodate both LVTTTL or Differential (LVPECL) inputs. The completely integrated PLL reduces jitter and simplifies board layout.

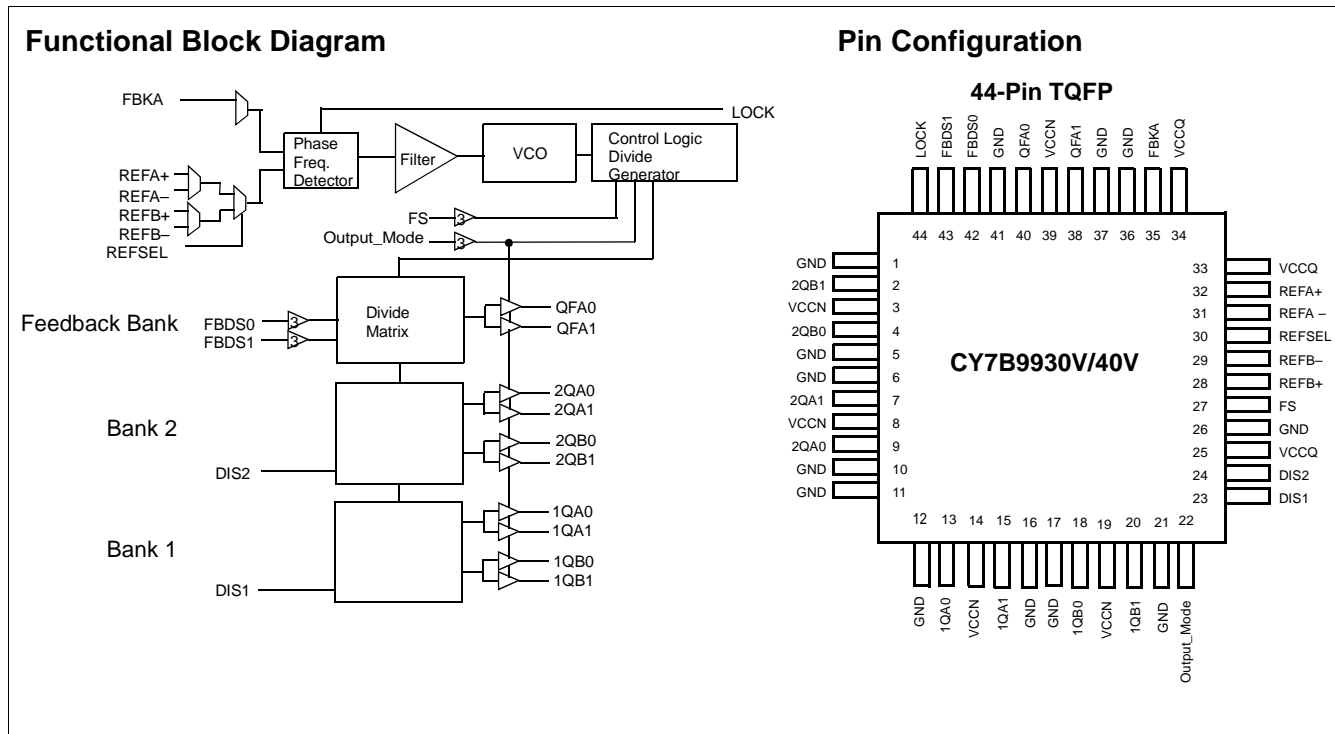



Pin Definitions^[1]

Name	I/O	Type	Description
FBKA	Input	LVTTL	Feedback Input.
REFA+, REFA–, REFB+, REFB–	Input	LVTTL/ LVDIFF	Reference Inputs: These inputs can operate as differential PECL or single-ended TTL reference inputs to the PLL. When operating as a single-ended LVTTL input, the complementary input must be left open.
REFSEL	Input	LVTTL	Reference Select Input: The REFSEL input controls how the reference input is configured. When LOW, it will use the REFA pair as the reference input. When HIGH, it will use the REFB pair as the reference input. This input has an internal pull-down.
FS	Input	3-level Input	Frequency Select: This input must be set according to the nominal frequency (f_{NOM}). See <i>Table 1</i> .
FBDS[0:1]	Input	3-level Input	Feedback Divider Function Select. These inputs determine the function of the QFA0 and QFA1 outputs. See <i>Table 2</i> .
DIS[1:2]	Input	LVTTL	Output Disable: Each input controls the state of the respective output bank. When HIGH, the output bank is disabled to the “HOLD-OFF” or “HI-Z” state; the disable state is determined by OUTPUT_MODE. When LOW, the [1:4]Q[A:B][0:1] is enabled. See <i>Table 3</i> . These inputs each have an internal pull-down.
LOCK	Output	LVTTL	PLL Lock Indicator: When HIGH, this output indicates the internal PLL is locked to the reference signal. When LOW, the PLL is attempting to acquire lock.
Output_Mode	Input	3-Level Input	Output Mode: This pin determines the clock outputs’ disable state. When this input is HIGH, the clock outputs will disable to high-impedance (HI-Z). When this input is LOW, the clock outputs will disable to “HOLD-OFF” mode. When in MID, the device will enter factory test mode.
QFA[0:1]	Output	LVTTL	Clock Feedback Output: This pair of clock outputs is intended to be connected to the FB input. These outputs have numerous divide options. The function is determined by the setting of the FBDS[0:1] pins.
[1:2]Q[A:B][0:1]	Output	LVTTL	Clock Output.
VCCN		PWR	Output Buffer Power: Power supply for each output pair.
VCCQ		PWR	Internal Power: Power supply for the internal circuitry.
GND		PWR	Device Ground.

Block Diagram Description

Phase Frequency Detector and Filter

These two blocks accept signals from the REF inputs (REFA+, REFA–, REFB+ or REFB–) and the FB input (FBKA). Correction information is then generated to control the frequency of the Voltage Controlled Oscillator (VCO). These two blocks, along with the VCO, form a Phase-Locked Loop (PLL) that tracks the incoming REF signal.

The RoboClockII™ Junior has a flexible REF input scheme. These inputs allow the use of either differential LVPECL or single-ended LVTTL inputs. To configure as single-ended LVTTL inputs, the complementary pin must be left open (internally pulled to 1.5V), then the other input pin can be used as a LVTTL input. The REF inputs are also tolerant to hot insertion.

The REF inputs can be changed dynamically. When changing from one reference input to the other reference input of the same frequency, the PLL is optimized to ensure that the clock outputs period will not be less than the calculated system budget ($t_{MIN} = t_{REF}$ (nominal reference clock period) – t_{CCJ} (cycle-to-cycle jitter) – t_{PDEV} (max. period deviation)) while reacquiring lock.

Note:

- For all three-state inputs, HIGH indicates a connection to V_{CC} , LOW indicates a connection to GND, and MID indicates an open connection. Internal termination circuitry holds an unconnected input to $V_{CC}/2$.
- The level to be set on FS is determined by the “nominal” operating frequency (f_{NOM}) of the VCO. f_{NOM} always appears on an output when the output is operating in the undivided mode. The REF and FB are at f_{NOM} when the output connected to FB is undivided.
- The maximum output frequency is 200 MHz.

VCO, Control Logic, and Divide Generator

The VCO accepts analog control inputs from the PLL filter block. The FS control pin setting determines the nominal operational frequency range of the divide by one output (f_{NOM}) of the device. f_{NOM} is directly related to the VCO frequency. There are two versions of the RoboClockII Junior, a low-speed device (CY7B9930V) where f_{NOM} ranges from 12 MHz to 100 MHz, and a high-speed device (CY7B9940V) which ranges from 24 MHz to 200 MHz. The FS setting for each device is shown in *Table 1*. The f_{NOM} frequency is seen on “divide-by-one” outputs.

Table 1. Frequency Range Select

FS ^[2]	CY7B9930V		CY7B9940V	
	f_{NOM} (MHz)		f_{NOM} (MHz)	
	Min.	Max.	Min.	Max.
LOW	12	26	24	52
MID	24	52	48	100
HIGH	48	100	96	200 ^[3]



Divide Matrix

The Divide Matrix is comprised of three independent banks: two banks of clock outputs and one bank for feedback. Each clock output bank has two pairs of low-skew, high-fanout output buffers ([1:2]Q[A:B][0:1]), and an output disable (DIS[1:2]).

The feedback bank has one pair of low-skew, high-fanout output buffers (QFA[0:1]). One of these outputs may connect to the selected feedback input (FBKA+). This feedback bank also has two divider function selects FBDS[0:1].

The divide capabilities for each bank are shown in *Table 2*.

Table 2. Output Divider Function

Function Selects		Output Divider Function		
FBDS1	FBDS0	Bank1	Bank2	Feedback Bank
LOW	LOW	/1	/1	/1
LOW	MID	/1	/1	/2
LOW	HIGH	/1	/1	/3
MID	LOW	/1	/1	/4
MID	MID	/1	/1	/5
MID	HIGH	/1	/1	/6
HIGH	LOW	/1	/1	/8
HIGH	MID	/1	/1	/10
HIGH	HIGH	/1	/1	/12

Output Disable Description

The outputs of Bank 1 and Bank 2 can be independently put into a HOLD-OFF or high-impedance state. The combination of the Output_Mode and DIS[1:2] inputs determines the clock outputs' state for each bank. When the DIS[1:2] is LOW, the outputs of the corresponding bank will be enabled. When the DIS[1:2] is HIGH, the outputs for that bank will be disabled to a high-impedance (HI-Z) or HOLD-OFF state depending on the Output_Mode input. *Table 3* defines the disabled output functions.

The HOLD-OFF state is intended to be a power saving feature. An output bank is disabled to the HOLD-OFF state in a maximum of six output clock cycles from the time when the disable input (DIS[1:2]) is HIGH. When disabled to the HOLD-OFF state, outputs are driven to a logic LOW state on its falling edge. This ensures the output clocks are stopped without glitch. When a bank of outputs is disabled to HI-Z state, the respective bank of outputs will go HI-Z immediately.

Table 3. DIS[1:2] Pin Functionality

OUTPUT_MODE	DIS[1:2]/FBDS	Output Mode
HIGH/LOW	LOW	ENABLED
HIGH	HIGH	HI-Z
LOW	HIGH	HOLD-OFF
MID	X	FACTORY TEST

Lock Detect Output Description

The LOCK detect output indicates the lock condition of the integrated PLL. Lock detection is accomplished by comparing the phase difference between the reference and feedback inputs. Phase error is declared when the phase difference between the two inputs is greater than the specified device propagation delay limit (t_{PD}).

When in the locked state, after four or more consecutive feedback clock cycles with phase-errors, the LOCK output will be forced LOW to indicate out-of-lock state.

When in the out-of-lock state, 32 consecutive phase-errorless feedback clock cycles are required to allow the LOCK output to indicate lock condition (LOCK = HIGH).

If the feedback clock is removed after LOCK has gone HIGH, a "Watchdog" circuit is implemented to indicate the out-of-lock condition after a time-out period by deasserting LOCK LOW. This time out period is based upon a divided down reference clock.

This assumes that there is activity on the selected REF input. If there is no activity on the selected REF input then the LOCK detect pin may not accurately reflect the state of the internal PLL.

Factory Test Mode Description

The device will enter factory test mode when the OUTPUT_MODE is driven to MID. In factory test mode, the device will operate with its internal PLL disconnected; input level supplied to the reference input will be used in place of the PLL output. In TEST mode the selected FB input must be tied LOW. All functions of the device are still operational in factory test mode except the internal PLL and output bank disables. The OUTPUT_MODE input is designed to be a static input. Dynamically toggling this input from LOW to HIGH may temporarily cause the device to go into factory test mode (when passing through the MID state).

Factory Test Reset

When in factory test mode (OUTPUT_MODE = MID), the device can be reset to a deterministic state by driving the DIS2 input HIGH. When the DIS2 input is driven HIGH in factory test mode, all clock outputs will go to HI-Z; after the selected reference clock pin has 5 positive transitions, all the internal finite state machines (FSM) will be set to a deterministic state. The deterministic state of the state machines will depend on the configurations of the divide selects and frequency select input. All clock outputs will stay in high-impedance mode and all FSMs will stay in the deterministic state until DIS2 is deasserted. When DIS2 is deasserted (with OUTPUT_MODE still at MID), the device will re-enter factory test mode.



Absolute Maximum Conditions

(Above which the useful life may be impaired. For user guidelines, not tested.)

Storage Temperature-40°C to +125°C
 Ambient Temperature with Power Applied ..-40°C to +125°C
 Supply Voltage to Ground Potential-0.5V to +4.6V
 DC Input Voltage-0.3V to $V_{CC}+0.5V$
 Output Current into Outputs (LOW)40 mA

Static Discharge Voltage..... >2000V
 (per MIL-STD-883, Method 3015)

Latch-up Current..... >±200 mA

Operating Range

Range	Ambient Temperature	V_{CC}
Commercial	0°C to +70°C	3.3V ±10%
Industrial	-40°C to +85°C	3.3V ±10%

Electrical Characteristics Over the Operating Range

Parameter	Description	Test Conditions	Min.	Max.	Unit	
LVTTL Compatible Output Pins (QFA[0:1], [1:4]Q[A:B][0:1], LOCK)						
V_{OH}	LVTTL HIGH Voltage	QFA[0:1], [1:2]Q[A:B][0:1]	$V_{CC} = \text{Min.}, I_{OH} = -30 \text{ mA}$	2.4	-	V
		LOCK	$I_{OH} = -2 \text{ mA}, V_{CC} = \text{Min.}$	2.4	-	V
V_{OL}	LVTTL LOW Voltage	QFA[0:1], [1:2]Q[A:B][0:1]	$V_{CC} = \text{Min.}, I_{OL} = 30 \text{ mA}$	-	0.5	V
		LOCK	$I_{OL} = 2 \text{ mA}, V_{CC} = \text{Min.}$	-	0.5	V
I_{OZ}	High-Impedance State Leakage Current		-100	100	μA	
LVTTL Compatible Input Pins (FBKA, REFA±, REFB±, REFSEL, DIS[1:2])						
V_{IH}	LVTTL Input HIGH	FBKA+, REF[A:B]±	$\text{Min.} \leq V_{CC} \leq \text{Max.}$	2.0	$V_{CC}+0.3$	V
		REFSEL, DIS[1:2]		2.0	$V_{CC}+0.3$	V
V_{IL}	LVTTL Input LOW	FBKA+, REF[A:B]±	$\text{Min.} \leq V_{CC} \leq \text{Max.}$	-0.3	0.8	V
		REFSEL, DIS[1:2]		-0.3	0.8	V
I_I	LVTTL $V_{IN} > V_{CC}$	FBKA+, REF[A:B]±	$V_{CC} = \text{GND}, V_{IN} = 3.63\text{V}$	-	100	μA
I_{IH}	LVTTL Input HIGH Current	FBKA+, REF[A:B]±	$V_{CC} = \text{Max.}, V_{IN} = V_{CC}$	-	500	μA
		REFSEL, DIS[1:2]	$V_{IN} = V_{CC}$	-	500	μA
I_{IL}	LVTTL Input LOW Current	FBKA+, REF[A:B]±	$V_{CC} = \text{Max.}, V_{IN} = \text{GND}$	-500	-	μA
		REFSEL, DIS[1:2]		-500	-	μA
3-Level Input Pins (FBDS[0:1], FS, Output_Mode)						
V_{IHH}	Three Level Input HIGH ^[4]		$\text{Min.} \leq V_{CC} \leq \text{Max.}$	$0.87 \cdot V_{CC}$	-	V
V_{IMM}	Three Level Input MID ^[4]		$\text{Min.} \leq V_{CC} \leq \text{Max.}$	$0.47 \cdot V_{CC}$	$0.53 \cdot V_{CC}$	V
V_{ILL}	Three Level Input LOW ^[4]		$\text{Min.} \leq V_{CC} \leq \text{Max.}$		$0.13 \cdot V_{CC}$	V
I_{IHH}	Three Level Input HIGH Current	3-level input pins	$V_{IN} = V_{CC}$	-	200	μA
I_{IMM}	Three Level Input MID Current	3-level input pins	$V_{IN} = V_{CC}/2$	-50	50	μA
I_{ILL}	Three Level Input LOW Current	3-level input pins	$V_{IN} = \text{GND}$	-200	-	μA
LVDIFF Input Pins (REF[A:B]±)						
V_{DIFF}	Input Differential Voltage			400	V_{CC}	mV
V_{IHHP}	Highest Input HIGH Voltage			1.0	V_{CC}	V
V_{ILLP}	Lowest Input LOW Voltage			GND	$V_{CC} - 0.4$	V
V_{COM}	Common Mode Range (crossing voltage)			0.8	V_{CC}	V

Note:

- These inputs are normally wired to V_{CC} , GND, or left unconnected (actual threshold voltages vary as a percentage of V_{CC}). Internal termination resistors hold the unconnected inputs at $V_{CC}/2$. If these inputs are switched, the function and timing of the outputs may glitch and the PLL may require an additional t_{LOCK} time before all data sheet limits are achieved.



Electrical Characteristics Over the Operating Range (continued)

Parameter	Description		Test Conditions	Min.	Max.	Unit
Operating Current						
I _{CCI}	Internal Operating Current	CY7B9930V	V _{CC} = Max., f _{MAX} ^[5]	–	200	mA
		CY7B9940V		–	200	mA
I _{CCN}	Output Current Dissipation/Pair ^[6]	CY7B9930V	V _{CC} = Max., C _{LOAD} = 25 pF, R _{LOAD} = 50Ω at V _{CC} /2, f _{MAX}	–	40	mA
		CY7B9940V		–	50	mA

Capacitance

Parameter	Description	Test Conditions	Min.	Max.	Unit
C _{IN}	Input Capacitance	T _A = 25°C, f = 1 MHz, V _{CC} = 3.3V	–	5	pF

Switching Characteristics Over the Operating Range^[7, 8, 9, 10, 11]

Parameter	Description		CY7B9930/40V-2		CY7B9930/40V-5		Unit
			Min.	Max.	Min.	Max.	
f _{in}	Clock Input Frequency	CY7B9930V	12	100	12	100	MHz
		CY7B9940V	24	200	24	200	MHz
f _{out}	Clock Output Frequency	CY7B9930V	12	100	12	100	MHz
		CY7B9940V	24	200	24	200	MHz
t _{SKEWPR}	Matched-Pair Skew ^[12, 13]		–	185	–	185	ps
t _{SKEWBNK}	Intrabank Skew ^[12, 13]		–	200	–	250	ps
t _{SKEW0}	Output-Output Skew (same frequency and phase, rise to rise, fall to fall) ^[12, 13]		–	250	–	550	ps
t _{SKEW1}	Output-Output Skew (same frequency and phase, other banks at different frequency, rise to rise, fall to fall) ^[12, 13]		–	250	–	650	ps
t _{CCJ1-3}	Cycle-to-Cycle Jitter (divide by 1 output frequency, FB = divide by 1, 2, 3)		–	150	–	150	ps Peak-Peak
t _{CCJ4-12}	Cycle-to-Cycle Jitter (divide by 1 output frequency, FB = divide by 4, 5, 6, 8, 10, 12)		–	100	–	100	ps Peak-Peak
t _{PD}	Propagation Delay, REF to FB Rise		–250	250	–500	500	ps
t _{PDDELTA}	Propagation Delay difference between two devices ^[14]		–	200		200	ps
t _{REFpwh}	REF input (Pulse Width HIGH) ^[15]		2.0	–	2.0	–	ns
t _{REFpwl}	REF input (Pulse Width LOW) ^[15]		2.0	–	2.0	–	ns
t _r /t _f	Output Rise/Fall Time ^[16]		0.15	2.0	0.15	2.0	ns
t _{LOCK}	PLL Lock Time From Power-up		–	10	–	10	ms
t _{RELOCK1}	PLL Re-Lock Time (from same frequency, different phase) with Stable Power Supply		–	500	–	500	μs

Notes:

5. I_{CCI} measurement is performed with Bank1 and FB Bank configured to run at maximum frequency (f_{NOM} = 100 MHz for CY7B9930V, f_{NOM} = 200 MHz for CY7B9940V), and all other clock output banks to run at half the maximum frequency. FS and OUTPUT_MODE are asserted to the HIGH state.
6. This is dependent upon frequency and number of outputs of a bank being loaded. The value indicates maximum I_{CCN} at maximum frequency and maximum load of 25 pF terminated to 50Ω at V_{CC}/2.
7. This is for non-three level inputs.
8. Assumes 25 pF Max. Load Capacitance up to 185 Mhz. At 200 MHz the max load is 10 pF.
9. Both outputs of pair must be terminated, even if only one is being used.
10. Each package must be properly decoupled.
11. AC parameters are measured at 1.5V, unless otherwise indicated.
12. Test Load C_L = 25 pF, terminated to V_{CC}/2 with 50Ω.
13. SKEW is defined as the time between the earliest and the latest output transition among all outputs for which the same phase delay has been selected when all outputs are loaded with 25 pF and properly terminated up to 185 MHz. At 200 MHz the max load is 10 pF.
14. Guaranteed by statistical correlation. Tested initially and after any design or process changes that may affect these parameters.
15. Tested initially and after any design or process changes that may affect these parameters.
16. Rise and fall times are measured between 2.0V and 0.8V.

Switching Characteristics Over the Operating Range^[7, 8, 9, 10, 11] (continued)

Parameter	Description	CY7B9930/40V-2		CY7B9930/40V-5		Unit
		Min.	Max.	Min.	Max.	
t _{RELOCK2}	PLL Re-Lock Time (from different frequency, different phase) with Stable Power Supply ^[17]	–	1000	–	1000	μs
t _{ODCV}	Output duty cycle deviation from 50% ^[11]	–1.0	1.0	–1.0	1.0	ns
t _{PWH}	Output HIGH time deviation from 50% ^[18]	–	1.5	–	1.5	ns
t _{PWL}	Output LOW time deviation from 50% ^[18]	–	2.0	–	2.0	ns
t _{PDEV}	Period deviation when changing from reference to reference ^[19]	–	0.025	–	0.025	UI
t _{OAZ}	DIS[1:2] HIGH to output high-impedance from ACTIVE ^[12, 20]	1.0	10	1.0	10	ns
t _{OZA}	DIS[1:2] LOW to output ACTIVE from output is high-impedance ^[20, 21]	0.5	14	0.5	14	ns

AC Test Loads and Waveform^[22]

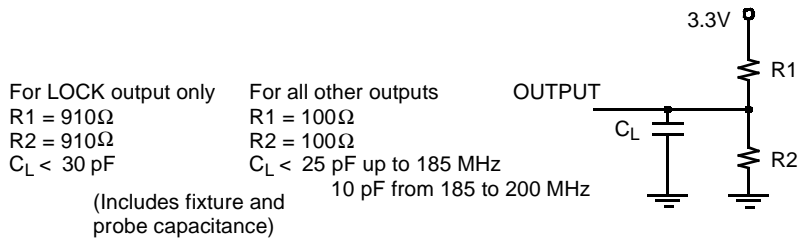

(a) LVTTL AC Test Load

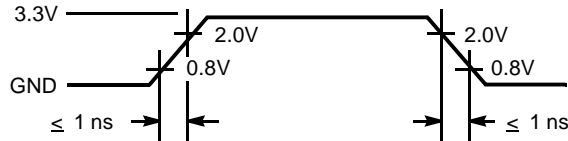

(b) TTL Input Test Waveform

Notes:

17. f_{NOM} must be within the frequency range defined by the same FS state.
18. t_{PWH} is measured at 2.0V. t_{PWL} is measured at 0.8V.
19. UI = Unit Interval. Examples: 1 UI is a full period. 0.1 UI is 10% of period.
20. Measured at 0.5V deviation from starting voltage.
21. For t_{OZA} minimum, C_L = 0 pF. For t_{OZA} maximum, C_L = 25 pF to 18 MHz, 10 pF from 185 to 200 MHz.
22. These figures are for illustration only. The actual ATE loads may vary.

AC Timing Diagrams^[11]

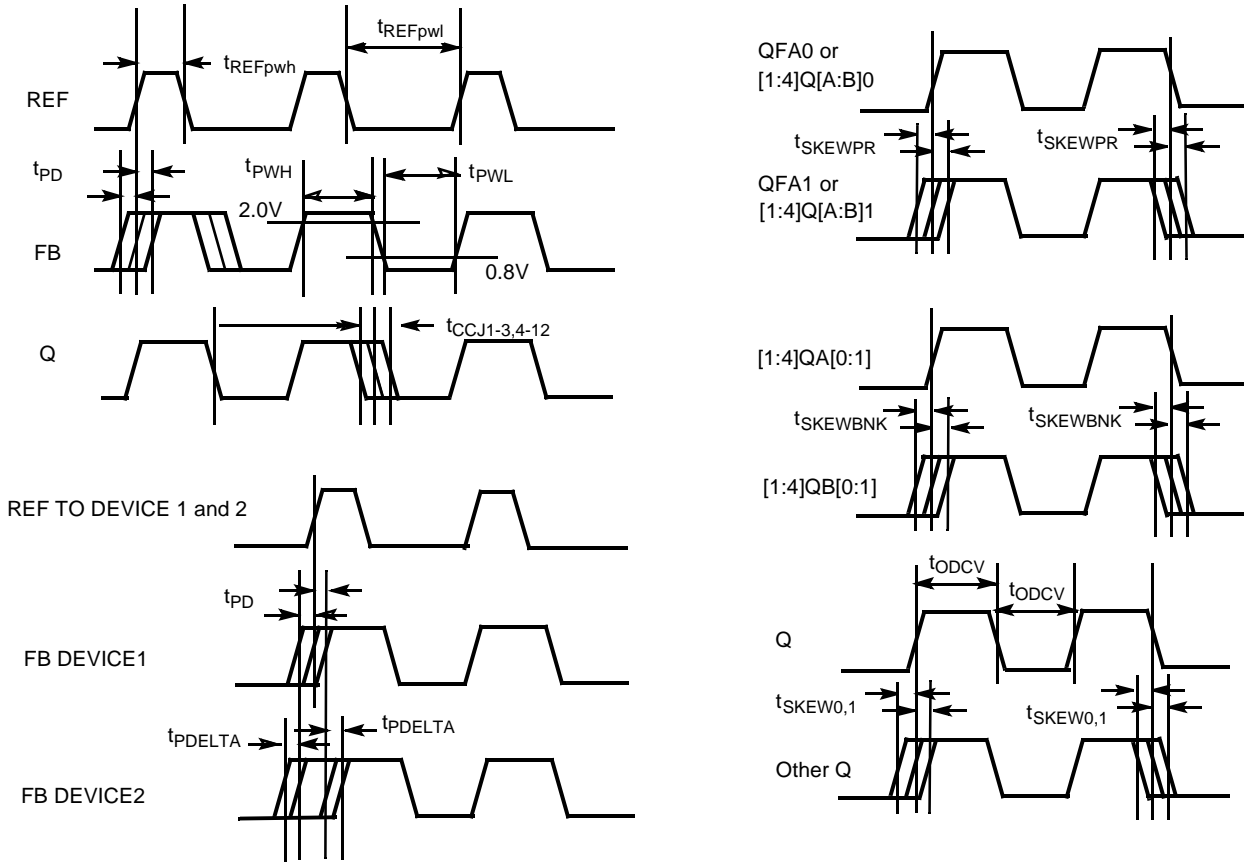

Ordering Information

Propagation Delay (ps)	Max. Speed (MHz)	Ordering Code	Package Name	Package Type	Operating Range
500	100	CY7B9930V-5AC	A44	44-Lead Thin Quad Flat Pack	Commercial
500	100	CY7B9930V-5AI	A44	44-Lead Thin Quad Flat Pack	Industrial
500	200	CY7B9940V-5AC	A44	44-Lead Thin Quad Flat Pack	Commercial
500	200	CY7B9940V-5AI	A44	44-Lead Thin Quad Flat Pack	Industrial
250	100	CY7B9930V-2AC	A44	44-Lead Thin Quad Flat Pack	Commercial
250	200	CY7B9940V-2AC	A44	44-Lead Thin Quad Flat Pack	Commercial
250	100	CY7B9930V-2AI	A44	44-Lead Thin Quad Flat Pack	Industrial
250	200	CY7B9940V-2AI	A44	44-Lead Thin Quad Flat Pack	Industrial

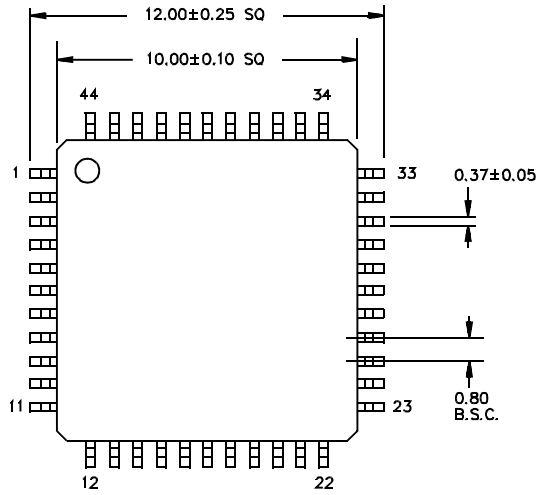
Package Diagrams
44-Lead Thin Plastic Quad Flat Pack A44

DIMENSIONS ARE IN MILLIMETERS

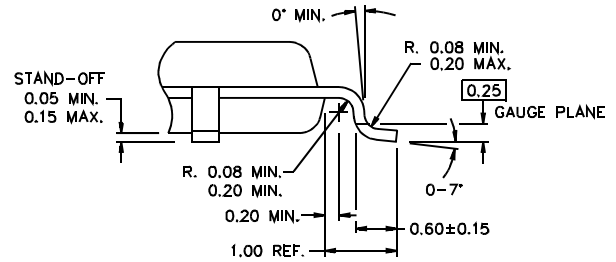

DETAIL A

51-85064-*B

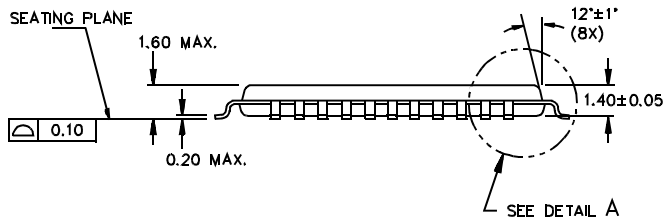

RoboClockII is a trademark of Cypress Semiconductor. All product and company names mentioned in this document are the trademarks of their respective holders.



Document History Page

Document Title: CY7B9930V/CY7B9940V RoboClockII™ Junior High-Speed Multi-Frequency PLL Clock Buffer				
Document Number: 38-07271				
REV.	ECN NO.	Issue Date	Orig. of Change	Description of Change
**	110536	12/02/01	SZV	Change from Spec number: 38-01141
*A	115109	7/03/02	HWT	Add 44TQFP package for both CY7B9930/40V – Industrial Operating Range
*B	128463	7/29/03	RGL	Added clock input frequency (f_{in}) specifications in the switching characteristics table. Added Min. values for the clock output frequency (f_{out}) in the switching characteristics table.