

US2AWF-HF Thru. US2MWF-HF

Reverse Voltage: 50 to 1000 Volts

Forward Current: 2 Amp

RoHS Device

Halogen Free

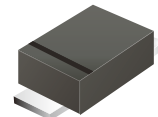

Features

- For surface mounted applications.
- Low profile package.
- Glass passivated chip junction.
- Easy to pick and place.
- High efficiency.

Mechanical data

- Case: SOD-123FL
- Terminals: Solderable per MIL-STD-750, method 2026.

Circuit Diagram

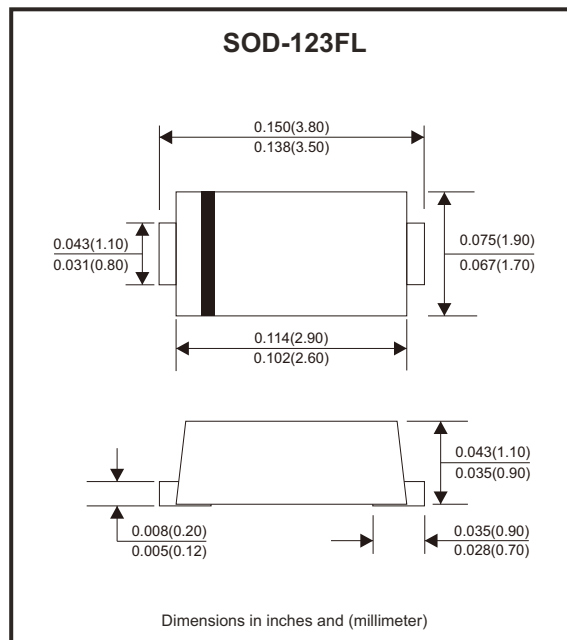

Maximum Ratings and Electrical Characteristics

Ratings at 25°C ambient temperature unless otherwise specified.

Single phase, half wave, 60Hz resistive or inductive load, for capacitive load, derate by 20%

Parameter	Symbols	US2AWF -HF	US2BWF -HF	US2DWF -HF	US2GWF -HF	US2JWF -HF	US2KWF -HF	US2MWF -HF	Units
Maximum repetitive peak reverse voltage	V _{RRM}	50	100	200	400	600	800	1000	V
Maximum RMS voltage	V _{RMS}	35	70	140	280	420	560	700	V
Maximum DC blocking voltage	V _{DC}	50	100	200	400	600	800	1000	V
Maximum average forward rectified current at T _c = 125°C	I _{F(AV)}	2							A
Peak forward surge current, 8.3ms single half sine-wave superimposed on rated load	I _{FSM}	50							A
Max. instantaneous forward voltage at 2A	V _F	1.0		1.3		1.68			V
Maximum DC reverse current at rated DC blocking voltage	I _R	5 100							μA
Maximum reverse recovery time (Note 1)	t _{rr}	50				75			ns
Typical thermal resistance (Note 2)	R _{θJA} R _{θJC}	75 22							°C/W
Operating and storage temperature range	T _j , T _{stg}	-55 ~ +150							°C

Notes: 1. Measured with I_F = 0.5A, I_R = 1A, I_{rr} = 0.25A.

2. P.C.B. mounted with 2.0" x 2.0" (5 x 5 cm) copper pad areas.

Company reserves the right to improve product design, functions and reliability without notice.

REV:A

Rating and Characteristic Curves (US2AWF-HF Thru. US2MWF-HF)

Fig.1 - Forward Current Derating Curve

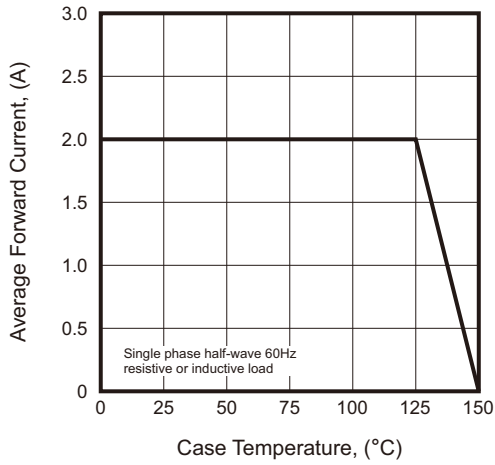

Fig.2 - Typical Reverse Characteristics

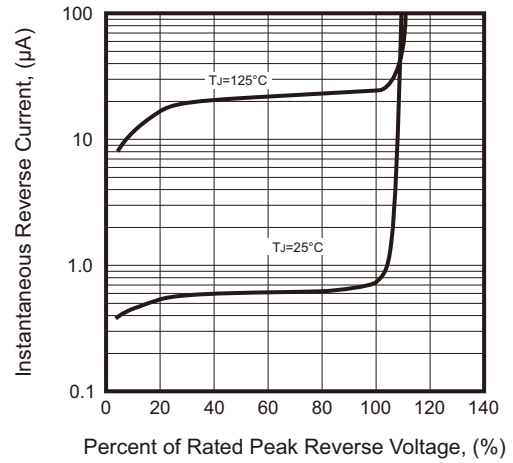

Fig.3 - Typical Forward Characteristic

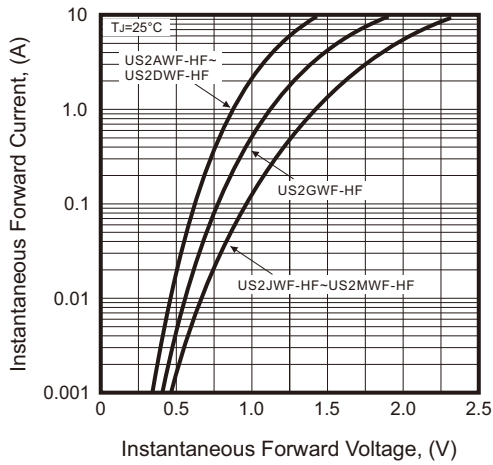
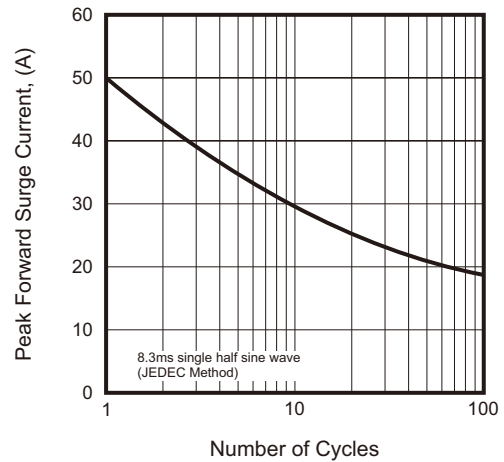
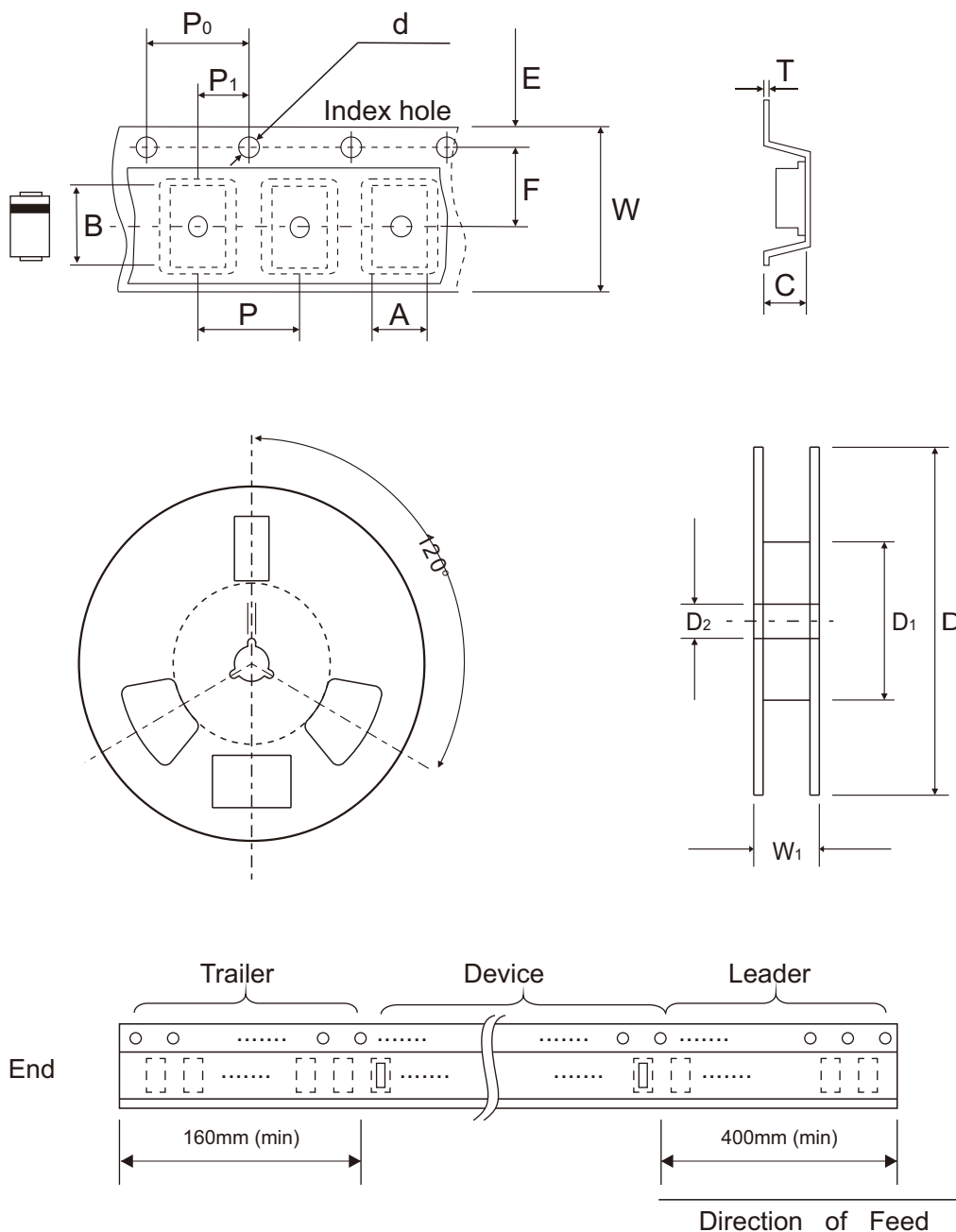

Fig.4 Maximum Non-Repetitive Peak Forward Surge Current



Reel Taping Specification



SOD-123FL	SYMBOL	A	B	C	d	D	D1	D2
	(mm)	2.05 ± 0.10	3.90 ± 0.10	1.28 ± 0.05	1.55 ± 0.05	180 ± 1.00	60.00 ± 1.50	13.00 ± 0.20
	(inch)	0.081 ± 0.004	0.154 ± 0.004	0.050 ± 0.002	0.061 ± 0.002	7.087 ± 0.039	2.362 ± 0.059	0.512 ± 0.008

SOD-123FL	SYMBOL	E	F	P	P0	P1	T	W	W1
	(mm)	1.75 ± 0.10	3.50 ± 0.10	4.00 ± 0.10	4.00 ± 0.10	2.00 ± 0.05	0.25 ± 0.02	8.00 ± 0.30	10.70 + 2.00 - 1.00
	(inch)	0.069 ± 0.004	0.138 ± 0.004	0.157 ± 0.004	0.157 ± 0.004	0.079 ± 0.002	0.010 ± 0.001	0.315 ± 0.012	0.421 + 0.079 - 0.039

Company reserves the right to improve product design, functions and reliability without notice.

REV:A

Marking Code

Part Number	Marking Code
US2AWF-HF	U2L
US2BWF-HF	
US2DWF-HF	
US2GWF-HF	U2M
US2JWF-HF	U2H
US2KWF-HF	
US2MWF-HF	

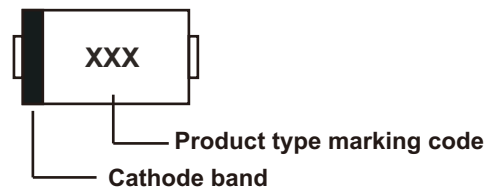

xxx = Product type marking code

Suggested PAD Layout

SIZE	SOD-123FL	
	(mm)	(inch)
A	2.00	0.079
B	1.20	0.047
C	1.20	0.047
D	4.40	0.173

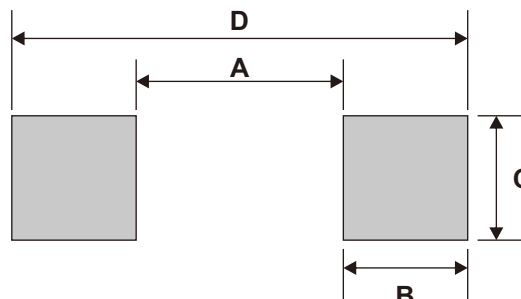

Note: 1. The pad layout is for reference purpose only.

Standard Packaging

Case Type	REEL PACK	
	REEL (pcs)	Reel Size (inch)
SOD-123FL	3,000	7