

SP1010 Series 3.5pF 8kV Unidirectional TVS Array

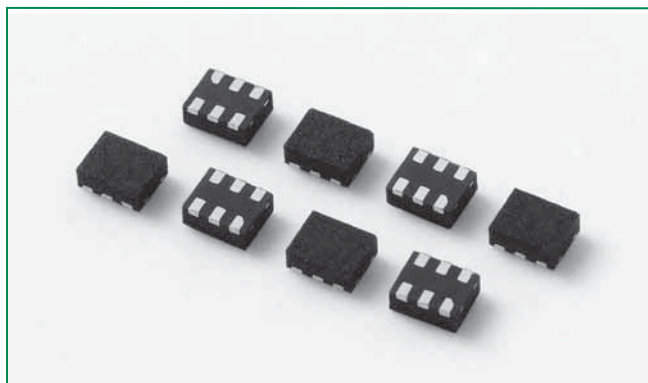

Description

Zener diodes fabricated in a proprietary silicon avalanche technology protect each I/O pin to provide a high level of protection for electronic equipment that may experience destructive electrostatic discharges (ESD). These robust diodes can safely absorb repetitive ESD strikes at the maximum level specified in the IEC 61000-4-2 international standard (Level 4, ±8kV contact discharge) without performance degradation. Their very low loading capacitance also makes them ideal for protection high-speed signal pins.

Pinout

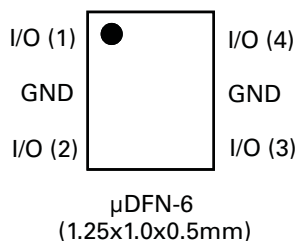

Features

- ESD, IEC61000-4-2, ±8kV contact, ±15kV air
- Lightning, IEC61000-4-5, 1A ($t_p=8/20\mu s$)
- Low capacitance of 3.5pF (TYP) per I/O
- Low leakage current of 1μA (MAX) at 5V
- Tiny μDFN(JEDEC MO-229) package (1.25mm x 1.0mm x 0.5mm)
- EFT protection IEC61000-4-4, 40A (5/50ns)

Functional Block Diagram

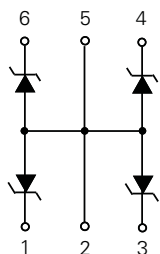

Applications

- Notebook
- Netbook
- Ultra mobile PC
- Mobile phone
- Portable navigation device
- Portable medical device
- MP3/PMP
- Digital camera

Application Example

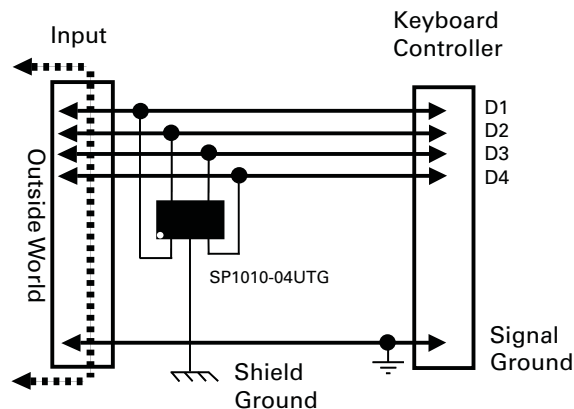

Life Support Note:

Not Intended for Use in Life Support or Life Saving Applications

The products shown herein are not designed for use in life sustaining or life saving applications unless otherwise expressly indicated.

Absolute Maximum Ratings

Symbol	Parameter	Value	Units
I_{PP}	Peak Pulse Current ($t_p=8/20\mu s$)	1.0	A
T_{OP}	Operating Temperature	-40 to 85	°C
T_{STOR}	Storage Temperature	-60 to 150	°C

CAUTION: Stresses above those listed in "Absolute Maximum Ratings" may cause permanent damage to the device. This is a stress only rating and operation of the device at these or any other conditions above those indicated in the operational sections of this specification is not implied.

Thermal Information

Parameter	Rating	Units
Storage Temperature Range	-65 to 150	°C
Maximum Junction Temperature	150	°C
Maximum Lead Temperature (Soldering 20-40s)	260	°C

Electrical Characteristics ($T_{OP}=25^\circ C$)

Parameter	Symbol	Test Conditions	Min	Typ	Max	Units
Reverse Voltage Drop	V_R	$I_R = 1mA$	7.0	7.8	8.5	V
Reverse Standoff Voltage	V_{RWM}	$I_R \leq 1\mu A$			6	V
Reverse Leakage Current	I_{LEAK}	$V_R = 5V$		0.1	1	μA
ESD Withstand Voltage ¹	V_{ESD}	IEC61000-4-2 (Contact Discharge)	± 8			kV
		IEC61000-4-2 (Air Discharge)	± 15			kV
Diode Capacitance ¹	C_D	Reverse Bias = 0V		6	7	pF
		Reverse Bias = 2.5V		3.5		pF

Note:

- Parameter is guaranteed by design and/or device characterization.

Capacitance vs. Reverse Bias

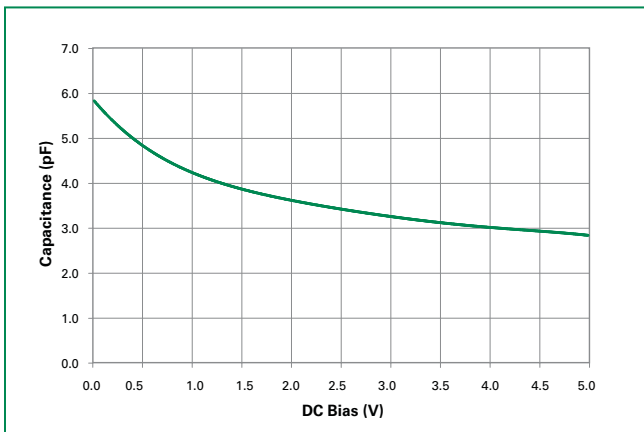

Insertion Loss (S21) I/O to GND

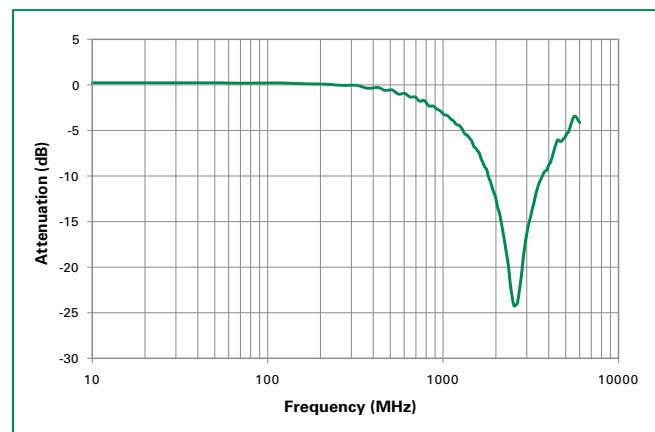

Soldering Parameters

Reflow Condition		Pb – Free assembly
Pre Heat	- Temperature Min ($T_{s(min)}$)	150°C
	- Temperature Max ($T_{s(max)}$)	200°C
	- Time (min to max) (t_s)	60 – 180 secs
Average ramp up rate (Liquidus) Temp (T_L) to peak		3°C/second max
$T_{s(max)}$ to T_L - Ramp-up Rate		3°C/second max
Reflow	- Temperature (T_L) (Liquidus)	217°C
	- Temperature (t_L)	60 – 150 seconds
Peak Temperature (T_p)		260 ^{+0/-5} °C
Time within 5°C of actual peak Temperature (t_p)		20 – 40 seconds
Ramp-down Rate		6°C/second max
Time 25°C to peak Temperature (T_p)		8 minutes Max.
Do not exceed		260°C

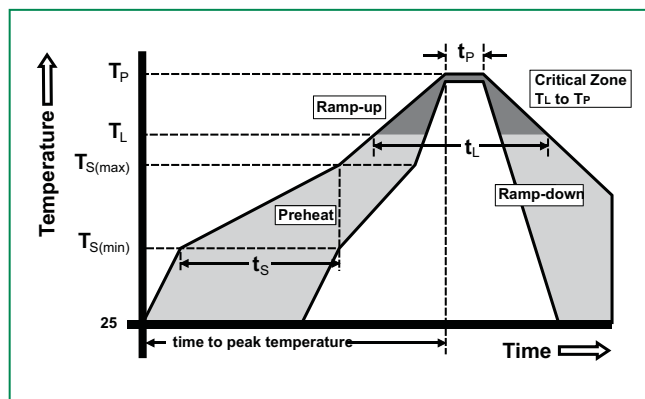

Package Dimensions — μ DFN-6 (1.25x1.0x0.5mm)

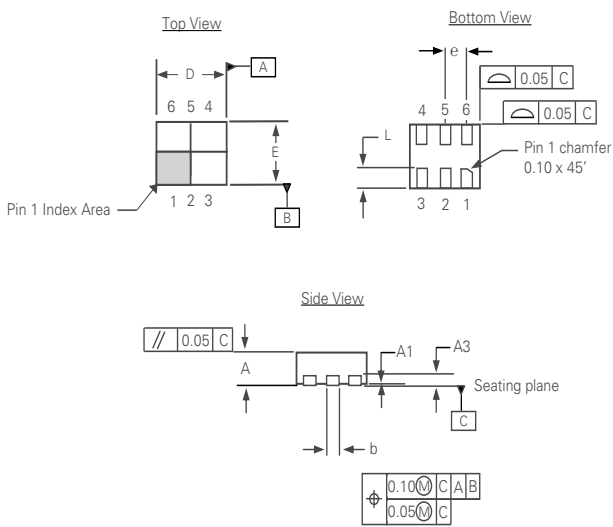

Recommended Soldering Pad for μ DFN-6L 1.25 x1.0x0.5 mm

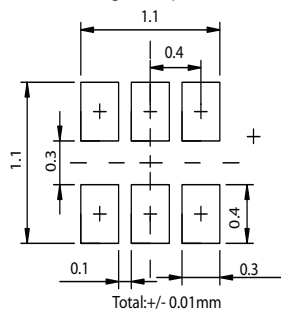

Package	μ DFN-6 (1.25x1.0x0.5mm)			
JEDEC	MO-229			
Symbol	Millimeters		Inches	
	Min	Max	Min	Max
A	0.45	0.55	0.018	0.022
A1	0.00	0.05	0.000	0.002
A3	0.127 REF		0.005 REF	
b	0.15	0.25	0.006	0.010
D	1.20	1.30	0.047	0.051
D2	-	-	-	-
E	0.95	1.05	0.037	0.041
E2	-	-	-	-
e	0.4 REF		0.016 REF	
L	0.25	0.35	0.010	0.014

SP1010

Part Numbering System

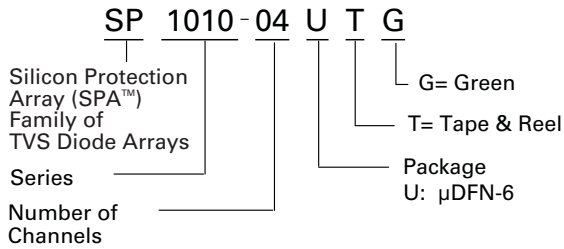

Part Marking System



Product Characteristics

Lead Plating	Pre-Plated Frame
Lead Material	Copper Alloy
Lead Coplanarity	0.0004 inches (0.102mm)
Substitute Material	Silicon
Body Material	Molded Epoxy
Flammability	UL 94 V-0

Notes :

1. All dimensions are in millimeters
2. Dimensions include solder plating.
3. Dimensions are exclusive of mold flash & metal burr.
4. Blo is facing up for mold and facing down for trim/form, i.e. reverse trim/form.
6. Package surface matte finish VDI 11-13.

Ordering Information

Part Number	Package	Marking	Min. Order Qty.
SP1010-04UTG	μ DFN-6 (1.25x1.0x0.5mm)	H4	3000

Embossed Carrier Tape & Reel Specification – μ DFN-6 (1.25x1.0x0.5mm)

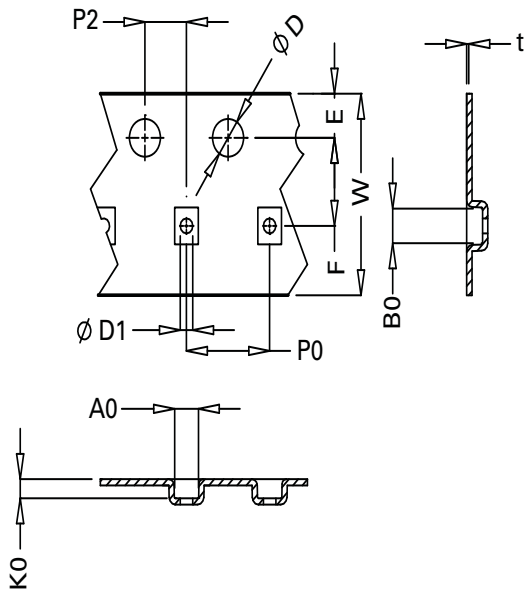

Symbol	Millimeters		Inches	
	Min	Max	Min	Max
E	1.65	1.85	0.06	0.07
F	3.45	3.55	0.14	0.14
D1	0.50	0.65	0.02	0.03
D	1.50 MIN		0.06 MIN	
P0	3.90	4.10	0.15	0.16
10P0	40.0 +/- 0.20		1.57 +/- 0.01	
W	7.90	8.30	0.31	0.33
P2	1.95	2.05	0.08	0.08
A0	1.09	1.19	0.04	0.05
B0	1.42	1.52	0.06	0.06
K0	0.71	0.81	0.03	0.03
t	0.25 TYP		0.01 TYP	