

# CD54/74AC563, CD54/74AC573 CD54/74ACT563, CD54/74ACT573

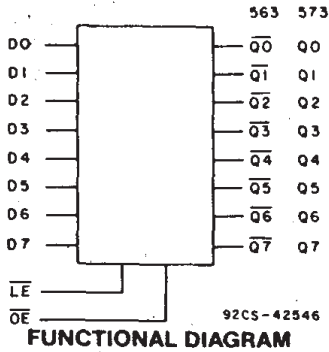

Data sheet acquired from Harris Semiconductor  
SCHS291



## Octal Transparent Latch, 3-State

CD54/74AC/ACT563 - Inverting  
CD54/74AC/ACT573 - Non-Inverting

### Type Features:

- Buffered inputs
- Typical propagation delay:  
4.3 ns @  $V_{CC} = 5\text{ V}$ ,  $T_A = 25^\circ\text{C}$ ,  $C_L = 50\text{ pF}$

The RCA-CD54/74AC563 and CD54/74AC573 and the CD54/74ACT563 and CD54/74ACT573 octal transparent 3-state latches use the RCA ADVANCED CMOS technology. The outputs are transparent to the inputs when the Latch Enable ( $\overline{LE}$ ) is HIGH. When the Latch Enable ( $\overline{LE}$ ) goes LOW, the data is latched. The Output Enable ( $\overline{OE}$ ) controls the 3-state outputs. When the Output Enable ( $\overline{OE}$ ) is HIGH, the outputs are in the high-impedance state. The latch operation is independent of the state of the Output Enable.

The CD74AC/ACT563 and CD74AC/ACT573 are supplied in 20-lead dual-in-line plastic packages (E suffix) and in 20-lead dual-in-line small-outline plastic packages (M suffix). Both package types are operable over the following temperature ranges: Commercial (0 to 70°C); Industrial (-40 to +85°C); and Extended Industrial/Military (-55 to +125°C).

The CD54AC/ACT563 and CD54AC/ACT573, available in chip form (H suffix), are operable over the -55 to +125°C temperature range.

### Family Features:

- Exceeds 2-kV ESD Protection - MIL-STD-883, Method 3015
- SCR-Latchup-resistant CMOS process and circuit design
- Speed of bipolar FAST\*/AS/S with significantly reduced power consumption
- Balanced propagation delays
- AC types feature 1.5-V to 5.5-V operation and balanced noise immunity at 30% of the supply
- $\pm 24\text{-mA}$  output drive current
  - Fanout to 15 FAST\* ICs
  - Drives 50-ohm transmission lines

\*FAST is a Registered Trademark of Fairchild Semiconductor Corp.

TRUTH TABLE

Output Enable	Latch Enable	Data	AC/ACT563 Output	AC/ACT573 Output
L	H	H	L	H
L	H	L	H	L
L	L	l	H	L
L	L	h	L	H
H	X	X	Z	Z

Note:

- L = Low voltage level
- H = High voltage level
- l = Low voltage level one set-up time prior to the high to low latch enable transition
- h = High voltage level one set-up time prior to the high to low latch enable transition.
- X = Don't Care
- Z = High Impedance State

This data sheet is applicable to the CD74AC563, CD54/74AC573, and CD54/74ACT573. The CD54AC563 and CD54/74ACT563 were not acquired from Harris Semiconductor.

# CD54/74AC563, CD54/74AC573 CD54/74ACT563, CD54/74ACT573

**MAXIMUM RATINGS, Absolute-Maximum Values:**

DC SUPPLY-VOLTAGE ( $V_{CC}$ )	.....	-0.5 to 6 V
DC INPUT DIODE CURRENT, $I_{IK}$ (for $V_i < -0.5$ V or $V_i > V_{CC} + 0.5$ V)	.....	$\pm 20$ mA
DC OUTPUT DIODE CURRENT, $I_{OK}$ (for $V_o < -0.5$ V or $V_o > V_{CC} + 0.5$ V)	.....	$\pm 50$ mA
DC OUTPUT SOURCE OR SINK CURRENT per Output Pin, $I_o$ (for $V_o > -0.5$ V or $V_o < V_{CC} + 0.5$ V)	.....	$\pm 50$ mA
DC $V_{CC}$ or GROUND CURRENT ( $I_{CC}$ or $I_{GND}$ )	.....	$\pm 100$ mA*
POWER DISSIPATION PER PACKAGE ( $P_D$ ):		
For $T_A = -55$ to $+100^\circ\text{C}$ (PACKAGE TYPE E)	.....	500 mW
For $T_A = +100$ to $+125^\circ\text{C}$ (PACKAGE TYPE E)	.....	Derate Linearly at 8 mW/ $^\circ\text{C}$ to 300 mW
For $T_A = -55$ to $+70^\circ\text{C}$ (PACKAGE TYPE M)	.....	400 mW
For $T_A = +70$ to $+125^\circ\text{C}$ (PACKAGE TYPE M)	.....	Derate Linearly at 6 mW/ $^\circ\text{C}$ to 70 mW
OPERATING-TEMPERATURE RANGE ( $T_A$ ):		
PACKAGE TYPE F	.....	$-55$ to $+125^\circ\text{C}$
PACKAGE TYPE E, M	.....	$-40$ to $+125^\circ\text{C}$
STORAGE TEMPERATURE ( $T_{stg}$ )		
.....	.....	$-65$ to $+150^\circ\text{C}$
LEAD TEMPERATURE (DURING SOLDERING):		
At distance $1/16 \pm 1/32$ in. ( $1.59 \pm 0.79$ mm) from case for 10 s maximum	.....	$+265^\circ\text{C}$
Unit inserted into PC board min. thickness $1/16$ in. ( $1.59$ mm) with solder contacting lead tips only	.....	$+300^\circ\text{C}$

\*For up to 4 outputs per device; add  $\pm 25$  mA for each additional output.

**RECOMMENDED OPERATING CONDITIONS:**

For maximum reliability, normal operating conditions should be selected so that operation is always within the following ranges:

CHARACTERISTIC	LIMITS		UNITS
	MIN.	MAX.	
Supply-Voltage Range, $V_{CC}$ *: (For $T_A =$ Full Package-Temperature Range) AC Types ACT Types	1.5 4.5	5.5 5.5	V V
DC Input or Output Voltage, $V_i, V_o$	0	$V_{CC}$	V
Operating Temperature, $T_A$ :	-55	+125	$^\circ\text{C}$
Input Rise and Fall Slew Rate, $dt/dv$ at 1.5 V to 3 V (AC Types) at 3.6 V to 5.5 V (AC Types) at 4.5 V to 5.5 V (ACT Types)	0 0 0	50 20 10	ns/V ns/V ns/V

\*Unless otherwise specified, all voltages are referenced to ground.

9

**TERMINAL ASSIGNMENT DIAGRAMS**

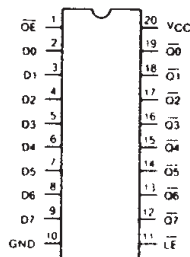

CD54/74AC563, CD54/74ACT563

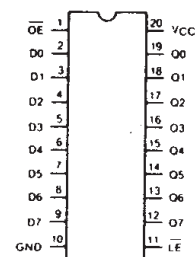

CD54/74AC573, CD54/74ACT573

# CD54/74AC563, CD54/74AC573 CD54/74ACT563, CD54/74ACT573

STATIC ELECTRICAL CHARACTERISTICS: AC Series

CHARACTERISTICS	TEST CONDITIONS		V <sub>CC</sub> (V)	AMBIENT TEMPERATURE (T <sub>A</sub> ) - °C						UNITS
				+25		-40 to +85		-55 to +125		
				MIN.	MAX.	MIN.	MAX.	MIN.	MAX.	
High-Level Input Voltage V <sub>IH</sub>			1.5	1.2	—	1.2	—	1.2	—	V
			3	2.1	—	2.1	—	2.1	—	
			5.5	3.85	—	3.85	—	3.85	—	
Low-Level Input Voltage V <sub>IL</sub>			1.5	—	0.3	—	0.3	—	0.3	V
			3	—	0.9	—	0.9	—	0.9	
			5.5	—	1.65	—	1.65	—	1.65	
High-Level Output Voltage V <sub>OH</sub>	V <sub>IH</sub> or V <sub>IL</sub>	-0.05	1.5	1.4	—	1.4	—	1.4	—	V
			3	2.9	—	2.9	—	2.9	—	
			4.5	4.4	—	4.4	—	4.4	—	
	#, *	-4	3	2.58	—	2.48	—	2.4	—	
			4.5	3.94	—	3.8	—	3.7	—	
			5.5	—	—	3.85	—	—	—	
-50	5.5	—	—	—	—	3.85	—			
	5.5	—	—	—	—	—	—			
Low-Level Output Voltage V <sub>OL</sub>	V <sub>IH</sub> or V <sub>IL</sub>	0.05	1.5	—	0.1	—	0.1	—	0.1	V
			3	—	0.1	—	0.1	—	0.1	
			4.5	—	0.1	—	0.1	—	0.1	
	#, *	12	3	—	0.36	—	0.44	—	0.5	
			4.5	—	0.36	—	0.44	—	0.5	
			5.5	—	—	—	1.65	—	—	
50	5.5	—	—	—	—	—	1.65			
	5.5	—	—	—	—	—	—			
Input Leakage Current I <sub>i</sub>	V <sub>CC</sub> or GND		5.5	—	±0.1	—	±1	—	±1	μA
3-State Leakage Current I <sub>oz</sub>	V <sub>IH</sub> or V <sub>IL</sub> V <sub>O</sub> = V <sub>CC</sub> or GND		5.5	—	±0.5	—	±5	—	±10	μA
Quiescent Supply Current, MSI I <sub>CC</sub>	V <sub>CC</sub> or GND	0	5.5	—	8	—	80	—	160	μA

#Test one output at a time for a 1-second maximum duration. Measurement is made by forcing current and measuring voltage to minimize power dissipation.

\*Test verifies a minimum 50-ohm transmission-line-drive capability at +85°C, 75 ohms at +125°C.

# CD54/74AC563, CD54/74AC573 CD54/74ACT563, CD54/74ACT573

**STATIC ELECTRICAL CHARACTERISTICS: ACT Series**

CHARACTERISTICS	TEST CONDITIONS		V <sub>CC</sub> (V)	AMBIENT TEMPERATURE (T <sub>A</sub> ) - °C						UNITS	
	V <sub>I</sub> (V)	I <sub>O</sub> (mA)		+25		-40 to +85		-55 to +125			
				MIN.	MAX.	MIN.	MAX.	MIN.	MAX.		
High-Level Input Voltage	V <sub>IH</sub>		4.5 to 5.5	2	—	2	—	2	—	V	
Low-Level Input Voltage	V <sub>IL</sub>		4.5 to 5.5	—	0.8	—	0.8	—	0.8	V	
High-Level Output Voltage	V <sub>OH</sub>	V <sub>IH</sub> or V <sub>IL</sub> #, *	-0.05	4.5	4.4	—	4.4	—	4.4	—	V
			-24	4.5	3.94	—	3.8	—	3.7	—	
			-75	5.5	—	—	3.85	—	—	—	
			-50	5.5	—	—	—	—	3.85	—	
Low-Level Output Voltage	V <sub>OL</sub>	V <sub>IH</sub> or V <sub>IL</sub> #, *	0.05	4.5	—	0.1	—	0.1	—	0.1	V
			24	4.5	—	0.36	—	0.44	—	0.5	
			75	5.5	—	—	—	1.65	—	—	
			50	5.5	—	—	—	—	—	1.65	
Input Leakage Current	I <sub>I</sub>	V <sub>CC</sub> or GND	5.5	—	±0.1	—	±1	—	±1	μA	
3-State Leakage Current	I <sub>OZ</sub>	V <sub>IH</sub> or V <sub>IL</sub> V <sub>O</sub> = V <sub>CC</sub> or GND	5.5	—	±0.5	—	±5	—	±10	μA	
Quiescent Supply Current, MSI	I <sub>CC</sub>	V <sub>CC</sub> or GND	0	5.5	—	8	—	80	—	160	μA
Additional Quiescent Supply Current per Input Pin TTL Inputs High 1 Unit Load	ΔI <sub>CC</sub>	V <sub>CC</sub> -2.1	4.5 to 5.5	—	2.4	—	2.8	—	3	mA	

9

#Test one output at a time for a 1-second maximum duration. Measurement is made by forcing current and measuring voltage to minimize power dissipation.

\*Test verifies a minimum 50-ohm transmission-line-drive capability at +85°C, 75 ohms at +125°C.

**ACT INPUT LOADING TABLE**

INPUT	UNIT LOAD*	
	ACT563	ACT573
$\overline{OE}$	0.87	0.87
$\overline{Dn}$	0.5	0.5
$\overline{LE}$	0.8	0.8

\*Unit load is ΔI<sub>CC</sub> limit specified in Static Characteristics Chart, e.g., 2.4 mA max. @ 25°C.

# CD54/74AC563, CD54/74AC573 CD54/74ACT563, CD54/74ACT573

PREREQUISITE FOR SWITCHING: AC Series

CHARACTERISTICS	SYMBOL	V <sub>CC</sub> (V)	AMBIENT TEMPERATURE (T <sub>A</sub> ) - °C				UNITS
			-40 to +85		-55 to +125		
			MIN.	MAX.	MIN.	MAX.	
LE Pulse Width	t <sub>w</sub>	1.5	44	—	50	—	ns
		3.3*	4.9	—	5.6	—	
		5†	3.5	—	4	—	
Setup Time Data to LE	t <sub>su</sub>	1.5	2	—	2	—	ns
		3.3	2	—	2	—	
		5	2	—	2	—	
Hold Time Data to LE	t <sub>h</sub>	1.5	33	—	38	—	ns
		3.3	3.7	—	4.2	—	
		5	2.6	—	3	—	

\*3.3 V: min. is @ 3 V

†5 V: min. is @ 4.5 V

SWITCHING CHARACTERISTICS: AC Series; t<sub>r</sub>, t<sub>f</sub> = 3 ns, C<sub>L</sub> = 50 pF

CHARACTERISTICS	SYMBOL	V <sub>CC</sub> (V)	AMBIENT TEMPERATURE (T <sub>A</sub> ) - °C				UNITS
			-40 to +85		-55 to +125		
			MIN.	MAX.	MIN.	MAX.	
Propagation Delays: Data to Qn AC563	t <sub>PLH</sub> t <sub>PHL</sub>	1.5	—	119	—	131	ns
		3.3*	3.8	13.4	3.7	14.7	
		5†	2.7	9.5	2.6	10.5	
AC573	t <sub>PLH</sub> t <sub>PHL</sub>	1.5	—	96	—	106	ns
		3.3	3.1	10.8	3	11.9	
		5	2.2	7.7	2.1	8.5	
LE on Qn AC563	t <sub>PLH</sub> t <sub>PHL</sub>	1.5	—	136	—	150	ns
		3.3	4.3	15.3	4.2	16.8	
		5	3.1	10.9	3	12	
AC573	t <sub>PLH</sub> t <sub>PHL</sub>	1.5	—	136	—	150	ns
		3.3	4.3	15.3	4.2	16.8	
		5	3.1	10.9	3	12	
Output Enable Times	t <sub>pZL</sub> t <sub>pZH</sub>	1.5	—	119	—	131	ns
		3.3	4.1	14.4	4	15.8	
		5	2.7	9.5	2.6	10.5	
Output Disable Times	t <sub>PLZ</sub> t <sub>PHZ</sub>	1.5	—	131	—	144	ns
		3.3	3.7	13.1	3.6	14.4	
		5	3	10.5	2.9	11.5	
Power Dissipation Capacitance	C <sub>PD</sub> §	—	63 Typ.		63 Typ.		pF
Min. (Valley) V <sub>OH</sub> During Switching of Other Outputs (Output Under Test Not Switching)	V <sub>OHV</sub> See Fig. 1	5	4 Typ. @ 25°C				V
Max. (Peak) V <sub>OL</sub> During Switching of Other Outputs (Output Under Test Not Switching)	V <sub>OLP</sub> See Fig. 1	5	1 Typ. @ 25°C				V
Input Capacitance	C <sub>i</sub>	—	—	10	—	10	pF
3-State Output Capacitance	C <sub>o</sub>	—	—	15	—	15	pF

\*3.3 V: min. is @ 3.6 V  
max. is @ 3 V

†5 V: min. is @ 5.5 V  
max. is @ 4.5 V

§C<sub>PD</sub> is used to determine the dynamic power consumption, per latch.

P<sub>D</sub> = V<sub>CC</sub><sup>2</sup> f<sub>i</sub> (C<sub>PD</sub> + C<sub>L</sub>) where f<sub>i</sub> = input frequency

C<sub>L</sub> = output load capacitance

V<sub>CC</sub> = supply voltage.

Technical Data

# CD54/74AC563, CD54/74AC573 CD54/74ACT563, CD54/74ACT573

**PREREQUISITE FOR SWITCHING: ACT Series**

CHARACTERISTICS	SYMBOL	V <sub>CC</sub> (V)	AMBIENT TEMPERATURE (T <sub>A</sub> ) - °C				UNITS
			-40 to +85		-55 to +125		
			MIN.	MAX.	MIN.	MAX.	
LE Pulse Width	t <sub>w</sub>	5†	3.5	—	4	—	ns
Setup Time Data to LE	t <sub>su</sub>	5	2	—	2	—	ns
Hold Time Data to LE	t <sub>h</sub>	5	2.6	—	3	—	ns

†5 V: min. is @ 4.5 V

**SWITCHING CHARACTERISTICS: ACT Series; t<sub>r</sub>, t<sub>f</sub> = 3 ns, C<sub>L</sub> = 50 pF**

CHARACTERISTICS	SYMBOL	V <sub>CC</sub> (V)	AMBIENT TEMPERATURE (T <sub>A</sub> ) - °C				UNITS
			-40 to +85		-55 to +125		
			MIN.	MAX.	MIN.	MAX.	
Propagation Delays: Data to Qn 563	t <sub>PLH</sub>	5†	2.9	10.4	2.9	11.4	ns
	t <sub>PHL</sub>						
573			2.7	9.4	2.6	10.4	
LE to Qn 563 573	t <sub>PLH</sub> t <sub>PHL</sub>	5	3.2	11.4	3.1	12.5	
Output Enable Times	t <sub>PZL</sub> t <sub>PZH</sub>	5	3.5	12.3	3.4	13.5	ns
Output Disable Times	t <sub>PLZ</sub> t <sub>PHZ</sub>	5	3.2	11.4	3.1	12.5	ns
Power Dissipation Capacitance	C <sub>PD</sub> §	—	63 Typ.		63 Typ.		pF
Min. (Valley) V <sub>OH</sub> During Switching of Other Outputs (Output Under Test Not Switching)	V <sub>OHV</sub> See Fig. 1	5	4 Typ. @ 25°C				V
Max. (Peak) V <sub>OL</sub> During Switching of Other Outputs (Output Under Test Not Switching)	V <sub>OLP</sub> See Fig. 1	5	1 Typ. @ 25°C				V
Input Capacitance	C <sub>I</sub>	—	—	10	—	10	pF
3-State Output Capacitance	C <sub>O</sub>	—	—	15	—	15	pF

†5 V: min. is @ 5.5 V  
max. is @ 4.5 V

§C<sub>PD</sub> is used to determine the dynamic power consumption, per latch.  
 $P_D = V_{CC}^2 f_i (C_{PD} + C_L) + V_{CC} \Delta I_{CC}$  where f<sub>i</sub> = input frequency  
 C<sub>L</sub> = output load capacitance  
 V<sub>CC</sub> = supply voltage.

9

# CD54/74AC563, CD54/74AC573 CD54/74ACT563, CD54/74ACT573

## PARAMETER MEASUREMENT INFORMATION

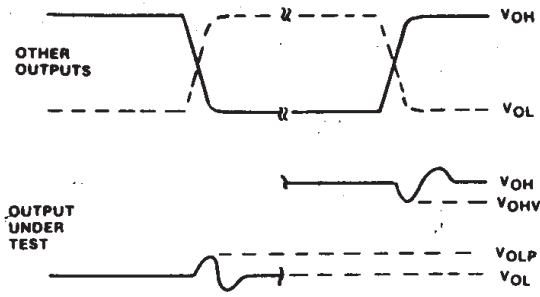

- NOTES:
1.  $V_{OHV}$  and  $V_{OLP}$  ARE MEASURED WITH RESPECT TO A GROUND REFERENCE NEAR THE OUTPUT UNDER TEST.
  2. INPUT PULSES HAVE THE FOLLOWING CHARACTERISTICS:  
PRR: 1 MHz,  $t_r$ : 3 ns,  $t_f$ : 3 ns, SKEW: 1 ns.
  3. R.F. FIXTURE WITH 700-MHz DESIGN RULES REQUIRED. IC SHOULD BE SOLDERED INTO TEST BOARD AND BYPASSED WITH 0.1  $\mu$ F CAPACITOR. SCOPE AND PROBES REQUIRE 700-MHz BANDWIDTH.

92CS-4240E

Fig. 1 - Simultaneous switching transient waveforms.

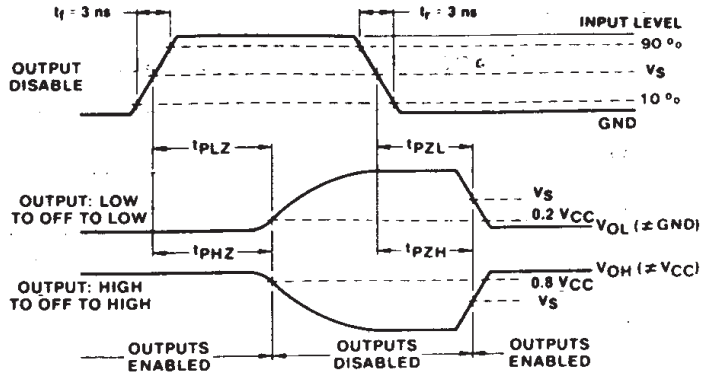

\*FOR AC SERIES ONLY: WHEN  $V_{CC} = 1.5$  V,  $R_L = 1$  k $\Omega$

92CM-42405

Fig. 2 - Three-state propagation delay waveforms and test circuit.

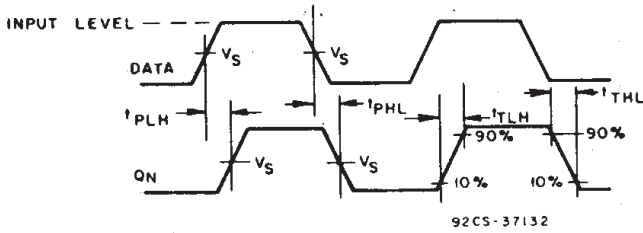

92CS-37132

Fig. 3 - Data to Qn output propagation delays.

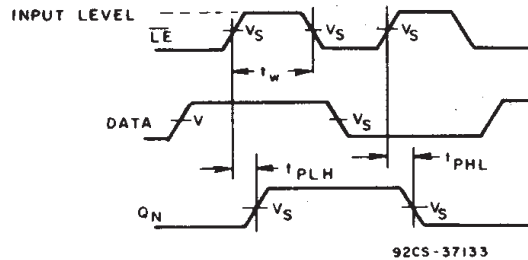

92CS-37133

Fig. 4 - Latch enable propagation delays.

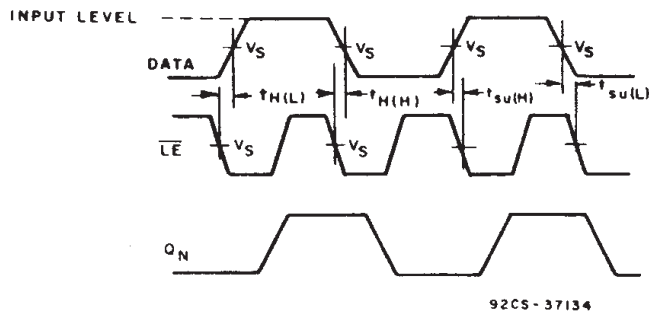

92CS-37134

Fig. 5 - Latch enable prerequisite times.

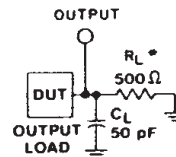

\*FOR AC SERIES ONLY: WHEN  $V_{CC} = 1.5$  V,  $R_L = 1$  k $\Omega$

92CS-42389

Fig. 6 - Test circuit.

	CD54/74AC	CD54/74ACT
Input Level	$V_{CC}$	3 V
Input Switching Voltage, $V_S$	0.5 $V_{CC}$	1.5 V
Output Switching Voltage, $V_S$	0.5 $V_{CC}$	0.5 $V_{CC}$

**PACKAGING INFORMATION**

Orderable Device	Status <sup>(1)</sup>	Package Type	Package Drawing	Pins	Package Qty	Eco Plan <sup>(2)</sup>	Lead/Ball Finish	MSL Peak Temp <sup>(3)</sup>
CD54AC573F3A	ACTIVE	CDIP	J	20	1	TBD	A42	N / A for Pkg Type
CD54ACT573F3A	ACTIVE	CDIP	J	20	1	TBD	A42	N / A for Pkg Type
CD74AC573E	ACTIVE	PDIP	N	20	20	Pb-Free (RoHS)	CU NIPDAU	N / A for Pkg Type
CD74AC573EE4	ACTIVE	PDIP	N	20	20	Pb-Free (RoHS)	CU NIPDAU	N / A for Pkg Type
CD74AC573M	ACTIVE	SOIC	DW	20	25	Green (RoHS & no Sb/Br)	CU NIPDAU	Level-1-260C-UNLIM
CD74AC573M96	ACTIVE	SOIC	DW	20	2000	Green (RoHS & no Sb/Br)	CU NIPDAU	Level-1-260C-UNLIM
CD74AC573M96E4	ACTIVE	SOIC	DW	20	2000	Green (RoHS & no Sb/Br)	CU NIPDAU	Level-1-260C-UNLIM
CD74AC573M96G4	ACTIVE	SOIC	DW	20	2000	Green (RoHS & no Sb/Br)	CU NIPDAU	Level-1-260C-UNLIM
CD74AC573ME4	ACTIVE	SOIC	DW	20	25	Green (RoHS & no Sb/Br)	CU NIPDAU	Level-1-260C-UNLIM
CD74AC573MG4	ACTIVE	SOIC	DW	20	25	Green (RoHS & no Sb/Br)	CU NIPDAU	Level-1-260C-UNLIM
CD74ACT573E	ACTIVE	PDIP	N	20	20	Pb-Free (RoHS)	CU NIPDAU	N / A for Pkg Type
CD74ACT573EE4	ACTIVE	PDIP	N	20	20	Pb-Free (RoHS)	CU NIPDAU	N / A for Pkg Type
CD74ACT573M	ACTIVE	SOIC	DW	20	25	Green (RoHS & no Sb/Br)	CU NIPDAU	Level-1-260C-UNLIM
CD74ACT573M96	ACTIVE	SOIC	DW	20	2000	Green (RoHS & no Sb/Br)	CU NIPDAU	Level-1-260C-UNLIM
CD74ACT573M96E4	ACTIVE	SOIC	DW	20	2000	Green (RoHS & no Sb/Br)	CU NIPDAU	Level-1-260C-UNLIM
CD74ACT573M96G4	ACTIVE	SOIC	DW	20	2000	Green (RoHS & no Sb/Br)	CU NIPDAU	Level-1-260C-UNLIM
CD74ACT573ME4	ACTIVE	SOIC	DW	20	25	Green (RoHS & no Sb/Br)	CU NIPDAU	Level-1-260C-UNLIM
CD74ACT573MG4	ACTIVE	SOIC	DW	20	25	Green (RoHS & no Sb/Br)	CU NIPDAU	Level-1-260C-UNLIM

<sup>(1)</sup> The marketing status values are defined as follows:

**ACTIVE:** Product device recommended for new designs.

**LIFEBUY:** TI has announced that the device will be discontinued, and a lifetime-buy period is in effect.

**NRND:** Not recommended for new designs. Device is in production to support existing customers, but TI does not recommend using this part in a new design.

**PREVIEW:** Device has been announced but is not in production. Samples may or may not be available.

**OBSOLETE:** TI has discontinued the production of the device.

<sup>(2)</sup> Eco Plan - The planned eco-friendly classification: Pb-Free (RoHS), Pb-Free (RoHS Exempt), or Green (RoHS & no Sb/Br) - please check <http://www.ti.com/productcontent> for the latest availability information and additional product content details.

**TBD:** The Pb-Free/Green conversion plan has not been defined.

**Pb-Free (RoHS):** TI's terms "Lead-Free" or "Pb-Free" mean semiconductor products that are compatible with the current RoHS requirements for all 6 substances, including the requirement that lead not exceed 0.1% by weight in homogeneous materials. Where designed to be soldered at high temperatures, TI Pb-Free products are suitable for use in specified lead-free processes.

**Pb-Free (RoHS Exempt):** This component has a RoHS exemption for either 1) lead-based flip-chip solder bumps used between the die and package, or 2) lead-based die adhesive used between the die and leadframe. The component is otherwise considered Pb-Free (RoHS compatible) as defined above.



**Green (RoHS & no Sb/Br):** TI defines "Green" to mean Pb-Free (RoHS compatible), and free of Bromine (Br) and Antimony (Sb) based flame retardants (Br or Sb do not exceed 0.1% by weight in homogeneous material)

<sup>(3)</sup> MSL, Peak Temp. -- The Moisture Sensitivity Level rating according to the JEDEC industry standard classifications, and peak solder temperature.

**Important Information and Disclaimer:**The information provided on this page represents TI's knowledge and belief as of the date that it is provided. TI bases its knowledge and belief on information provided by third parties, and makes no representation or warranty as to the accuracy of such information. Efforts are underway to better integrate information from third parties. TI has taken and continues to take reasonable steps to provide representative and accurate information but may not have conducted destructive testing or chemical analysis on incoming materials and chemicals. TI and TI suppliers consider certain information to be proprietary, and thus CAS numbers and other limited information may not be available for release.

In no event shall TI's liability arising out of such information exceed the total purchase price of the TI part(s) at issue in this document sold by TI to Customer on an annual basis.

**TAPE AND REEL INFORMATION**

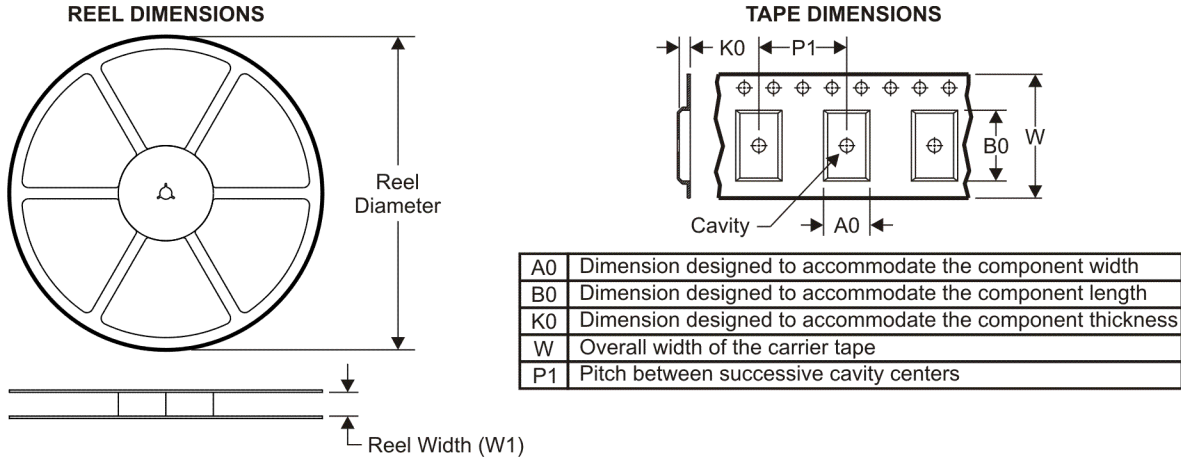

**QUADRANT ASSIGNMENTS FOR PIN 1 ORIENTATION IN TAPE**



\*All dimensions are nominal

Device	Package Type	Package Drawing	Pins	SPQ	Reel Diameter (mm)	Reel Width W1 (mm)	A0 (mm)	B0 (mm)	K0 (mm)	P1 (mm)	W (mm)	Pin1 Quadrant
CD74AC573M96	SOIC	DW	20	2000	330.0	24.4	10.8	13.0	2.7	12.0	24.0	Q1
CD74ACT573M96	SOIC	DW	20	2000	330.0	24.4	10.8	13.0	2.7	12.0	24.0	Q1

**TAPE AND REEL BOX DIMENSIONS**



\*All dimensions are nominal

Device	Package Type	Package Drawing	Pins	SPQ	Length (mm)	Width (mm)	Height (mm)
CD74AC573M96	SOIC	DW	20	2000	346.0	346.0	41.0
CD74ACT573M96	SOIC	DW	20	2000	346.0	346.0	41.0

J (R-GDIP-T\*\*)

14 LEADS SHOWN

CERAMIC DUAL IN-LINE PACKAGE



DIM \ PINS **	14	16	18	20
A	0.300 (7,62) BSC	0.300 (7,62) BSC	0.300 (7,62) BSC	0.300 (7,62) BSC
B MAX	0.785 (19,94)	.840 (21,34)	0.960 (24,38)	1.060 (26,92)
B MIN	—	—	—	—
C MAX	0.300 (7,62)	0.300 (7,62)	0.310 (7,87)	0.300 (7,62)
C MIN	0.245 (6,22)	0.245 (6,22)	0.220 (5,59)	0.245 (6,22)



4040083/F 03/03

- NOTES:
- All linear dimensions are in inches (millimeters).
  - This drawing is subject to change without notice.
  - This package is hermetically sealed with a ceramic lid using glass frit.
  - Index point is provided on cap for terminal identification only on press ceramic glass frit seal only.
  - Falls within MIL STD 1835 GDIP1-T14, GDIP1-T16, GDIP1-T18 and GDIP1-T20.

N (R-PDIP-T\*\*)

PLASTIC DUAL-IN-LINE PACKAGE

16 PINS SHOWN



- NOTES:
- A. All linear dimensions are in inches (millimeters).
  - B. This drawing is subject to change without notice.
  - Falls within JEDEC MS-001, except 18 and 20 pin minimum body length (Dim A).
  - The 20 pin end lead shoulder width is a vendor option, either half or full width.

DW (R-PDSO-G20)

PLASTIC SMALL OUTLINE

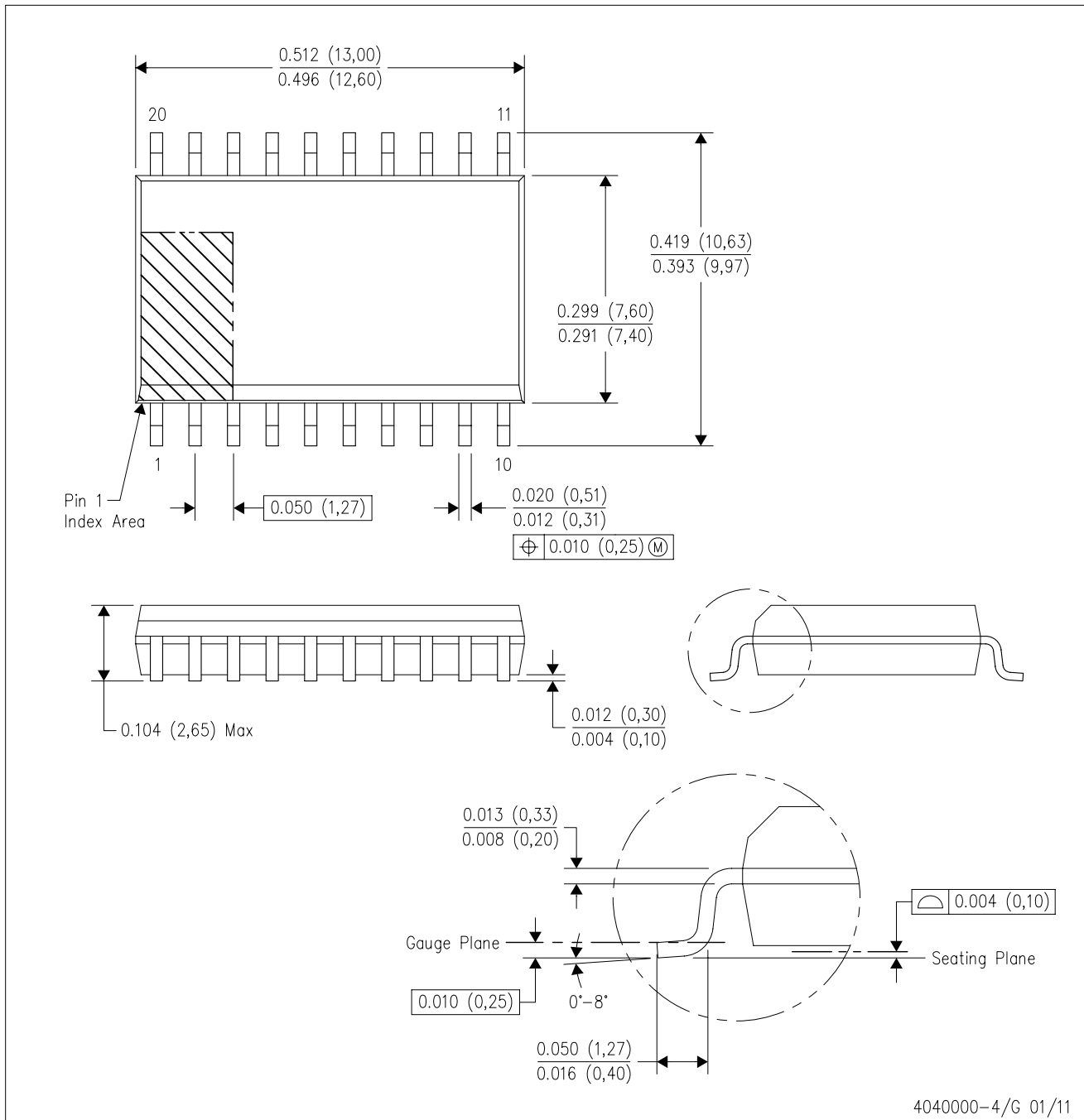

- NOTES:
- A. All linear dimensions are in inches (millimeters). Dimensioning and tolerancing per ASME Y14.5M-1994.
  - B. This drawing is subject to change without notice.
  - C. Body dimensions do not include mold flash or protrusion not to exceed 0.006 (0,15).
  - D. Falls within JEDEC MS-013 variation AC.

## IMPORTANT NOTICE

Texas Instruments Incorporated and its subsidiaries (TI) reserve the right to make corrections, modifications, enhancements, improvements, and other changes to its products and services at any time and to discontinue any product or service without notice. Customers should obtain the latest relevant information before placing orders and should verify that such information is current and complete. All products are sold subject to TI's terms and conditions of sale supplied at the time of order acknowledgment.

TI warrants performance of its hardware products to the specifications applicable at the time of sale in accordance with TI's standard warranty. Testing and other quality control techniques are used to the extent TI deems necessary to support this warranty. Except where mandated by government requirements, testing of all parameters of each product is not necessarily performed.

TI assumes no liability for applications assistance or customer product design. Customers are responsible for their products and applications using TI components. To minimize the risks associated with customer products and applications, customers should provide adequate design and operating safeguards.

TI does not warrant or represent that any license, either express or implied, is granted under any TI patent right, copyright, mask work right, or other TI intellectual property right relating to any combination, machine, or process in which TI products or services are used. Information published by TI regarding third-party products or services does not constitute a license from TI to use such products or services or a warranty or endorsement thereof. Use of such information may require a license from a third party under the patents or other intellectual property of the third party, or a license from TI under the patents or other intellectual property of TI.

Reproduction of TI information in TI data books or data sheets is permissible only if reproduction is without alteration and is accompanied by all associated warranties, conditions, limitations, and notices. Reproduction of this information with alteration is an unfair and deceptive business practice. TI is not responsible or liable for such altered documentation. Information of third parties may be subject to additional restrictions.

Resale of TI products or services with statements different from or beyond the parameters stated by TI for that product or service voids all express and any implied warranties for the associated TI product or service and is an unfair and deceptive business practice. TI is not responsible or liable for any such statements.

TI products are not authorized for use in safety-critical applications (such as life support) where a failure of the TI product would reasonably be expected to cause severe personal injury or death, unless officers of the parties have executed an agreement specifically governing such use. Buyers represent that they have all necessary expertise in the safety and regulatory ramifications of their applications, and acknowledge and agree that they are solely responsible for all legal, regulatory and safety-related requirements concerning their products and any use of TI products in such safety-critical applications, notwithstanding any applications-related information or support that may be provided by TI. Further, Buyers must fully indemnify TI and its representatives against any damages arising out of the use of TI products in such safety-critical applications.

TI products are neither designed nor intended for use in military/aerospace applications or environments unless the TI products are specifically designated by TI as military-grade or "enhanced plastic." Only products designated by TI as military-grade meet military specifications. Buyers acknowledge and agree that any such use of TI products which TI has not designated as military-grade is solely at the Buyer's risk, and that they are solely responsible for compliance with all legal and regulatory requirements in connection with such use.

TI products are neither designed nor intended for use in automotive applications or environments unless the specific TI products are designated by TI as compliant with ISO/TS 16949 requirements. Buyers acknowledge and agree that, if they use any non-designated products in automotive applications, TI will not be responsible for any failure to meet such requirements.

Following are URLs where you can obtain information on other Texas Instruments products and application solutions:

### Products

Audio	<a href="http://www.ti.com/audio">www.ti.com/audio</a>
Amplifiers	<a href="http://amplifier.ti.com">amplifier.ti.com</a>
Data Converters	<a href="http://dataconverter.ti.com">dataconverter.ti.com</a>
DLP® Products	<a href="http://www.dlp.com">www.dlp.com</a>
DSP	<a href="http://dsp.ti.com">dsp.ti.com</a>
Clocks and Timers	<a href="http://www.ti.com/clocks">www.ti.com/clocks</a>
Interface	<a href="http://interface.ti.com">interface.ti.com</a>
Logic	<a href="http://logic.ti.com">logic.ti.com</a>
Power Mgmt	<a href="http://power.ti.com">power.ti.com</a>
Microcontrollers	<a href="http://microcontroller.ti.com">microcontroller.ti.com</a>
RFID	<a href="http://www.ti-rfid.com">www.ti-rfid.com</a>
OMAP Mobile Processors	<a href="http://www.ti.com/omap">www.ti.com/omap</a>
Wireless Connectivity	<a href="http://www.ti.com/wirelessconnectivity">www.ti.com/wirelessconnectivity</a>

### Applications

Automotive and Transportation	<a href="http://www.ti.com/automotive">www.ti.com/automotive</a>
Communications and Telecom	<a href="http://www.ti.com/communications">www.ti.com/communications</a>
Computers and Peripherals	<a href="http://www.ti.com/computers">www.ti.com/computers</a>
Consumer Electronics	<a href="http://www.ti.com/consumer-apps">www.ti.com/consumer-apps</a>
Energy and Lighting	<a href="http://www.ti.com/energy">www.ti.com/energy</a>
Industrial	<a href="http://www.ti.com/industrial">www.ti.com/industrial</a>
Medical	<a href="http://www.ti.com/medical">www.ti.com/medical</a>
Security	<a href="http://www.ti.com/security">www.ti.com/security</a>
Space, Avionics and Defense	<a href="http://www.ti.com/space-avionics-defense">www.ti.com/space-avionics-defense</a>
Video and Imaging	<a href="http://www.ti.com/video">www.ti.com/video</a>

TI E2E Community Home Page

[e2e.ti.com](http://e2e.ti.com)

Mailing Address: Texas Instruments, Post Office Box 655303, Dallas, Texas 75265  
Copyright © 2012, Texas Instruments Incorporated